

Video Cassette Recorder

Operating Instructions

Owner's record

The model and serial numbers are located at the rear of the unit. Record these numbers in the spaces provided below. Refer to them whenever you call upon your Sony dealer regarding this product.

Model No. _____

Serial No. _____

VHS

Hi-Fi

VCR *plus*

SLV-775HF

SLV-775HF PX

SLV-776HF

WARNING

To prevent fire or shock hazard, do not expose the unit to rain or moisture.

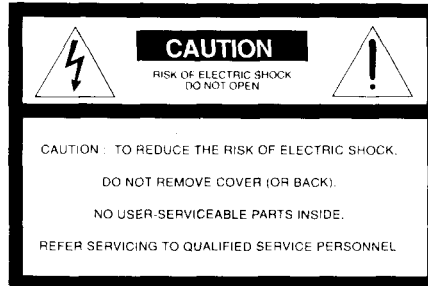

This symbol is intended to alert the user to the presence of uninsulated "dangerous voltage" within the product's enclosure that may be of sufficient magnitude to constitute a risk of electric shock to persons.



This symbol is intended to alert the user to the presence of important operating and maintenance (servicing) instructions in the literature accompanying the appliance.

CAUTION

To prevent electric shock, do not use this polarized AC plug with an extension cord, receptacle or other outlet unless the blades can be fully inserted to prevent blade exposure.

WARNING

The AC power cord must be changed at qualified service shop.

Precautions

Safety

- For SLV-775HF/776HF, operate the unit only on 120 V AC, 60 Hz. For SLV-775HF PX, operate the unit on 110 to 240 V AC, 50/60 Hz.
- If anything falls into the cabinet, unplug the unit and have it checked by qualified personnel before operating it any further.
- This unit is not disconnected from the AC power source (mains) as long as it is connected to the wall outlet, even if the unit itself has been turned off.
- One blade of the plug is wider than the other for the purpose of safety and will fit into the power outlet only one way. If you are unable to insert the plug fully into the outlet, contact your Sony dealer.
- Unplug the unit from the wall outlet if you do not intend to use it for an extended period of time. To disconnect the cord, pull it out by the plug, never by the cord.

Installing

- Allow adequate air circulation to prevent internal heat buildup.

- Do not place the unit on surfaces (rugs, blankets, etc.) or near materials (curtains, draperies) that may block the ventilation slots.
- Do not install the unit near heat sources such as radiators or air ducts, or in a place subject to direct sunlight, excessive dust, mechanical vibration or shock.
- Do not install the unit in an inclined position. It is designed to be operated in a horizontal position only.
- Keep the unit and cassettes away from equipment with strong magnets, such as microwave ovens or large loudspeakers.
- Do not place heavy objects on the unit.
- If the unit is brought directly from a cold to a warm location, moisture may condense inside the VCR and cause damage to the video head and tape. When you first install the unit, or when you move it from a cold to a warm location, wait for about one hour before operating the unit.

Information

For customers in the USA

CAUTION

You are cautioned that any changes or modifications not expressly approved in this manual could void your authority to operate this equipment.

NOTE:

This equipment has been tested and found to comply with the limits for a Class B digital device, pursuant to Part 15 of the FCC Rules. These limits are designed to provide reasonable protection against harmful interference in a residential installation. This equipment generates, uses, and can radiate radio frequency energy and, if not installed and used in accordance with the instructions, may cause harmful interference to radio communications. However, there is no guarantee that interference will not occur in a particular installation. If this equipment does cause harmful interference to radio or television reception, which can be determined by turning the equipment off and on, the user is encouraged to try to correct the interference by one or more of the following measures:

- Reorient or relocate the receiving antenna.
- Increase the separation between the equipment and receiver.
- Connect the equipment into an outlet on a circuit different from that to which the receiver is connected.
- Consult the dealer or an experienced radio/TV technician for help.

You are cautioned that any changes or modifications not expressly approved in this manual could void your authority to operate this equipment.

Caution

Television programs, films, video tapes and other materials may be copyrighted. Unauthorized recording of such material may be contrary to the provisions of the copyright laws. Also, use of this recorder with cable television transmission may require authorization from the cable television transmission and/or program owner.

Table of contents

Getting Started

- 4 Step 1: Unpacking
- 5 Step 2: Setting up the remote commander
- 7 Step 3: Hookups
- 30 Selecting a language
- 31 Setting the clock
- 38 Setting up cable box control
- 43 Presetting channels
- 47 Setting up VCR Plus+*

Basic Operations

- 50 Playing a tape
- 52 Recording TV programs
- 55 Recording TV programs using VCR Plus+
- 58 Setting the timer manually

Additional Operations

- 60 Playing/searching at various speeds
- 61 Recording TV programs using the quick timer
- 62 Checking/changing/canceling timer settings
- 64 Recording stereo and bilingual programs
- 66 Adjusting the picture
- 67 Changing menu options
- 68 Editing with another VCR

Additional Information

- 70 General setup information
- 72 Troubleshooting
- 74 Specifications
- 75 Index to parts and controls
- 79 Index
- back cover
Quick reference to using the VCR

* VCR Plus+ and PlusCode are trademarks of Gemstar Development Corporation. VCR Plus+ system is manufactured under license from Gemstar Development Corporation.

Step 1

Unpacking

Check that you have received the following items with the VCR:

- Remote commander

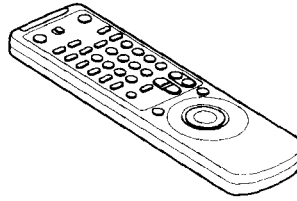

- Cable Mouse (cable box controller)

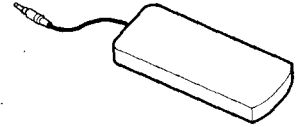

- Size AA (R6) batteries

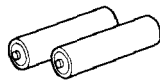

- 75-ohm coaxial cable with F-type connectors

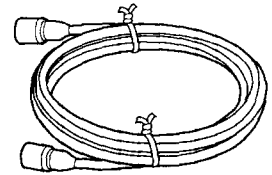

- Audio/video cable (3-phono, 1 mini to 3-phono, 1 mini)

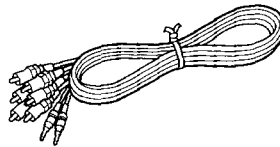

- Plug adaptor (SLV-775HF PX only)

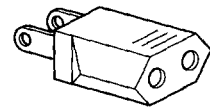

Step 2

Setting up the remote commander

Inserting the batteries

Insert two size AA (R6) batteries by matching the + and - on the batteries to the diagram inside the battery compartment.

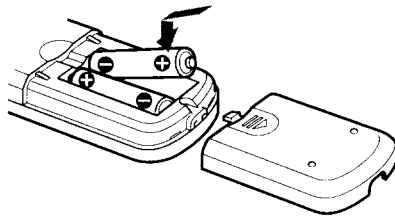

Using the remote commander

You can use this remote commander to operate this VCR and a Sony TV. Buttons on the remote commander marked with a dot (•) can be used to operate your Sony TV.

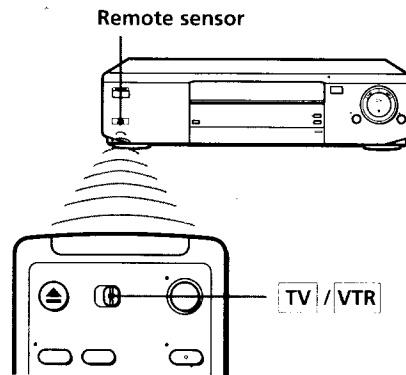

To operate	Set TV/VTR to
the VCR	VTR and point at the remote sensor on the VCR
a Sony TV	TV and point at the remote sensor on the TV

Notes

- With normal use, the batteries should last about three to six months.
- If you do not use the remote commander for an extended period of time, remove the batteries to avoid possible damage from battery leakage.
- Do not use a new battery with an old one.
- Do not use different types of batteries.

continued

Step 2: Setting up the remote commander (continued)

Controlling other TVs with the remote commander

The remote commander is preprogrammed to control non-Sony TVs. If your TV is listed in the table below, set the appropriate manufacturer's code number.

- 1 Set [TV]/[VTR] at the top of the remote commander to [TV].
- 2 Hold down POWER, and enter your TV's code number(s) using the number buttons. Then release POWER.

Now you can use the POWER, VOL +/-, CH +/-, and TV/VTR buttons to control your TV. You can also use the buttons marked with a dot (•) to control a Sony TV. To control the VCR, reset [TV]/[VTR] to [VTR].

Code numbers of controllable TVs

If more than one code number is listed, try entering them one at a time until you find the one that works with your TV.

Manufacturer	Code number	Manufacturer	Code number	Manufacturer	Code number
Sony	01	JVC	09	RCA	04,10
Akai	04	KMC	03	Sampo	12
AOC	04	Magnavox	03,08,12	Sanyo	11
Centurion	12	Marantz	04,13	Scott	12
Coronado	03	MGA/Mitsubishi	04,12,13,17	Sears	07,10,11
Curis-Mathes	12	NEC	04,12	Sharp	03,05,18
Daytron	12	Panasonic	06,19	Sylvania	08,12
Emerson	03,04,14	Philco	03,04	Teknika	03,08,14
Fisher	11	Philips	08	Toshiba	07
General Electric	06,10	Pioneer	16	Wards	03,04,12
Gold Star	03,04,17	Portland	03	Yorx	12
Hitachi	02,03	Quasar	06,18	Zenith	15
J.C.Penny	04,12	Radio Shack	05,14		

Notes

- If the TV uses a different remote control system from the one programmed to work with the VCR, you cannot control your TV with the remote commander.
- If you enter a new code number, the code number previously entered will be erased.
- When you replace the batteries of the remote commander, the code number automatically resets to 01 (Sony). Reset the appropriate code number.

Step 3

Hookups

Selecting the best hookup option

There are many ways in which your VCR can be hooked up. To hook up your VCR so that it works best for you, first scan through the table below. Then use the accompanying diagrams and procedures on the following pages to set up your VCR.

If you have	Use	Refer to
TV that has audio/video inputs	Audio/video (A/V) hookup , then follow one of the hookups below.	Pages 8 and 9
Cable box that is compatible with the VCR's cable box control feature	Hookup 1	Pages 10 to 12
No cable box or incompatible cable box with only a few scrambled channels	Hookup 2	Pages 13 to 15
Antenna only, no cable TV	Hookup 3	Pages 16 to 18
Incompatible cable box with many scrambled channels	Hookup 4	Pages 19 to 21
DSS [®] receiver	Hookup 5	Pages 22 to 24
Incompatible cable box with only a few scrambled channels, using an A/B switch	Hookup 6	Pages 25 to 29

After you've completed the connections, follow the instructions for setup. During setup, if you need more details on the procedure described, page numbers are provided where you can find complete, step-by-step instructions.

After you've completed the setup, you're ready to use your VCR. Procedures differ depending on the hookup you used. For an overview, refer to "Quick reference to using the VCR" on the back cover.

Before you get started

- Turn off the power to all equipment.
- Do not connect the AC power cords until all of the connections are completed.
- Be sure you make connections firmly. Loose connections may cause picture distortion.
- If your TV doesn't match any of the examples provided, see your nearest Sony dealer or qualified technician.

* DSS[®] is a registered trademark of DIRECTV, Inc., a unit of Hughes Electronics Corporation.

If your TV has audio/video (A/V) input jacks, you will get a better picture and sound if you hook up your VCR using these connections. In addition, for a true "home theater" experience, you should connect the audio outputs of your VCR or TV to your stereo system. If your TV doesn't have A/V inputs, see the following pages for antenna or cable hookups.

If your TV has the S-Link™* (A/V bus control) function, hook up your VCR using the connection shown on page 9. Your TV will automatically switch to the A/V inputs for your VCR when you play back or operate menu on the VCR.

If you're not planning to use your VCR to record programs, you're finished setting up the VCR after you've made the connections shown on pages 8 and 9. If you want to record off-air or off your cable TV system, complete these connections first, and then go to the following pages for antenna or cable hookups.

* S-Link™ is a trademark of Sony Corporation.

A Use this hookup if your TV has stereo jacks

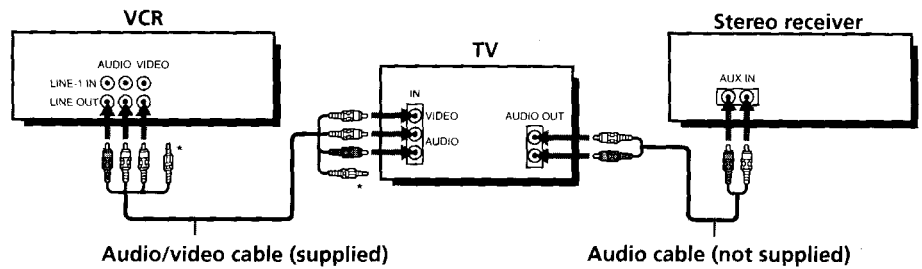

* Do not connect the miniplugs for this hookup.

B Use this hookup if your TV doesn't have stereo jacks

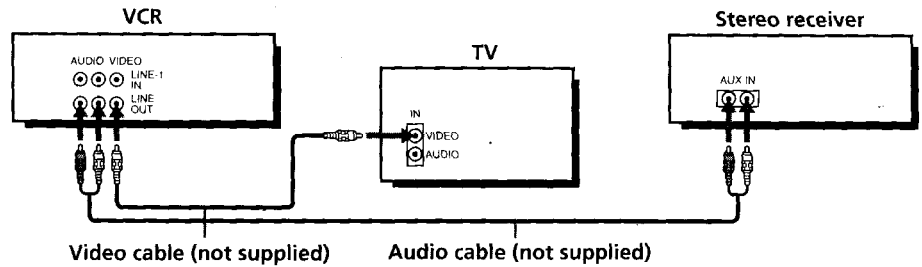

Note

- To play a tape in stereo, you must use the A/V connection.

C Use this hookup if your TV has the S-Link™ function

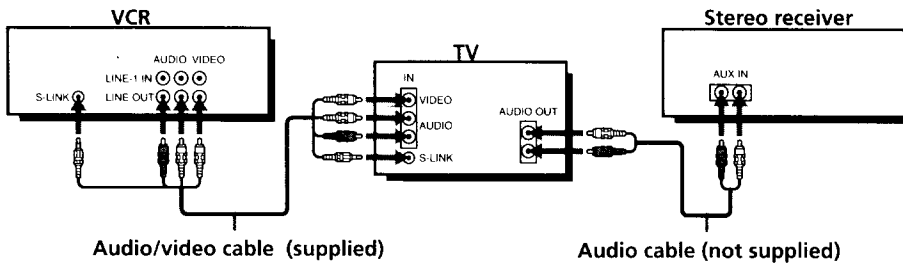

Getting Started

Caution

Connections between the VCR's VHF/UHF connector and the antenna terminals of the TV receiver should be made only as shown in the following instructions. Failure to do so may result in operation that violates the regulations of the Federal Communications Commission regarding the use and operation of RF devices. Never connect the output of the VCR to an antenna or make simultaneous (parallel) antenna and VCR connections at the antenna terminals of your receiver.

Note to CATV system installer (in USA)

This reminder is provided to call the CATV system installer's attention to Article 820-40 of the NEC that provides guidelines for proper grounding and, in particular, specifies that the cable ground shall be connected to the grounding system of the building, as close to the point of cable entry as practical.

continued

Hookup 1

Using cable box control

Recommended use

You should use this hookup if you have a cable box, especially if your cable system scrambles all or most channels. This hookup allows the VCR's cable box control feature to control the channel on the cable box, simplifying the recording process. A list of compatible cable boxes is on page 39.

What you can do with this hookup

- Record any channel using the VCR's cable box control feature to select channels on the cable box

What you can't do

- Record with the cable box turned off
- Record one channel while watching another channel

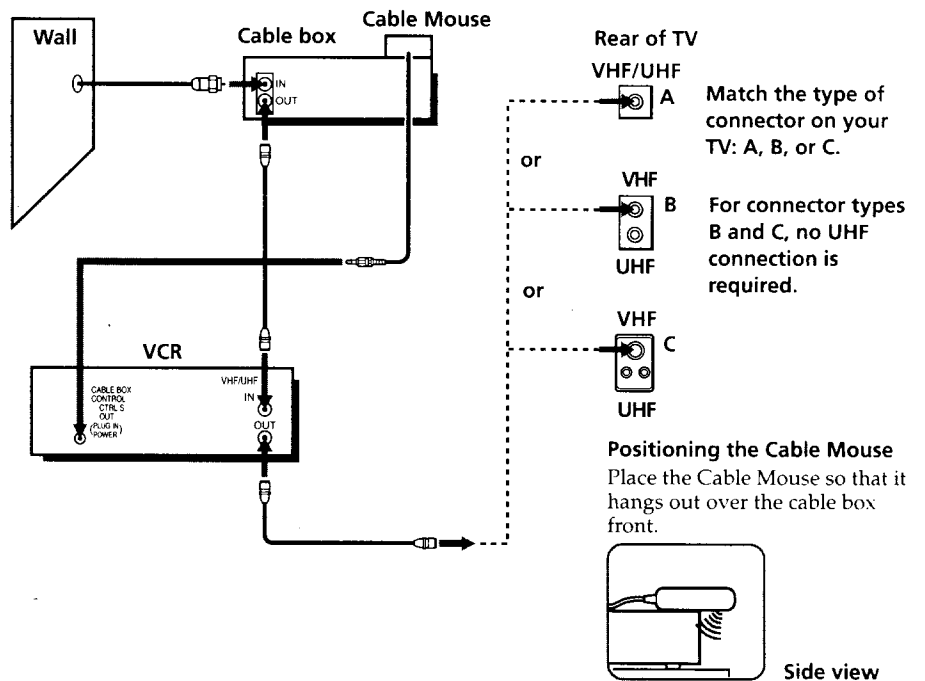

Hookup 1: VCR setup

- 1 Set the RF UNIT switch to CH 3 or CH 4, whichever channel is not used in your area. If both are used, set the switch to either channel.

For details, see page 70.

If you made A/V connections (from page 8), you can skip this step.

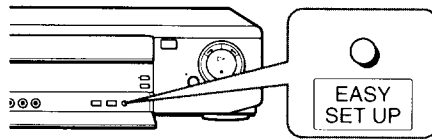
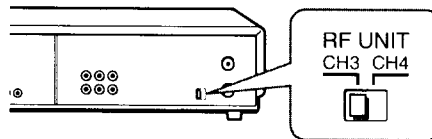

- 2 Turn on your cable box.
- 3 Press EASY SET UP on the VCR.

- 1 The LANGUAGE menu appears. Change the on-screen display language to Spanish (ESPAÑOL) or French (FRANÇAIS) if desired, and press the Joystick (EXECUTE). For details, see page 30.

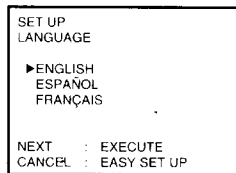

- 2 The CLOCK SET menu appears. Select AUTO and press the Joystick (EXECUTE). For details, see page 31.

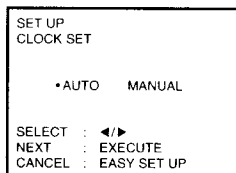

- 3 The CABLE BOX CONTROL menu appears. Select ON. For details, see page 38.

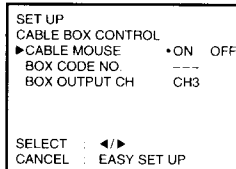

- 4 Enter your cable box code number and push Joystick to ↓.

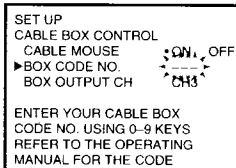

- 5 Select your cable box output channel and press the Joystick (EXECUTE).

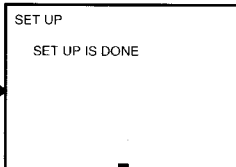
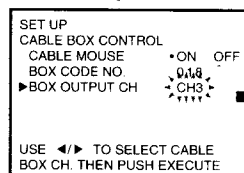

Normal display

continued

Getting Started

Step 3: Hookups (continued)

Hookup 1: VCR Plus+ channel setup

- 1 Find the VCR Plus+ Channel Listing in your program guide. For details, see page 47.
- 2 If the channels in the program guide are different from the channels that you actually use on your TV, set the channels that are different as follows. For details, see page 48.

- 1 Press MENU and select SET VCR PLUS+ CHANNELS.

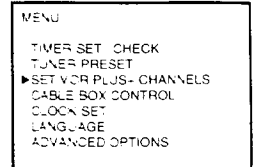

- 2 Enter the program guide channel, then the channel you use on your TV.

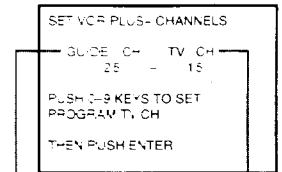

- 3 Press the Joystick (EXECUTE).

Program guide channel

Your actual TV channel

Automatic clock setting

Once you've set up the VCR, it automatically sets the clock the first time you turn off the VCR. After that, whenever you turn off the VCR, it checks the time and adjusts the clock, even for Daylight Saving Time. The VCR sets the clock by picking up a time signal provided by some TV channels.

If you want to use the timer to record right away, or if the channels in your area do not carry time signals, set the clock manually. For details, see pages 36 to 37.

Note

- To use the automatic clock setting feature, leave the cable box on.

No cable box, or incompatible cable box with only a few scrambled channels

Recommended use

Use this hookup if you do not have a cable box. Also use this hookup if your cable company cannot supply a cable box that is compatible with the VCR's cable box control feature, and your cable system scrambles only a few channels.

What you can do with this hookup

- Record any unscrambled channel by selecting the channel on the VCR

What you can't do

- Record scrambled channels that require a cable box

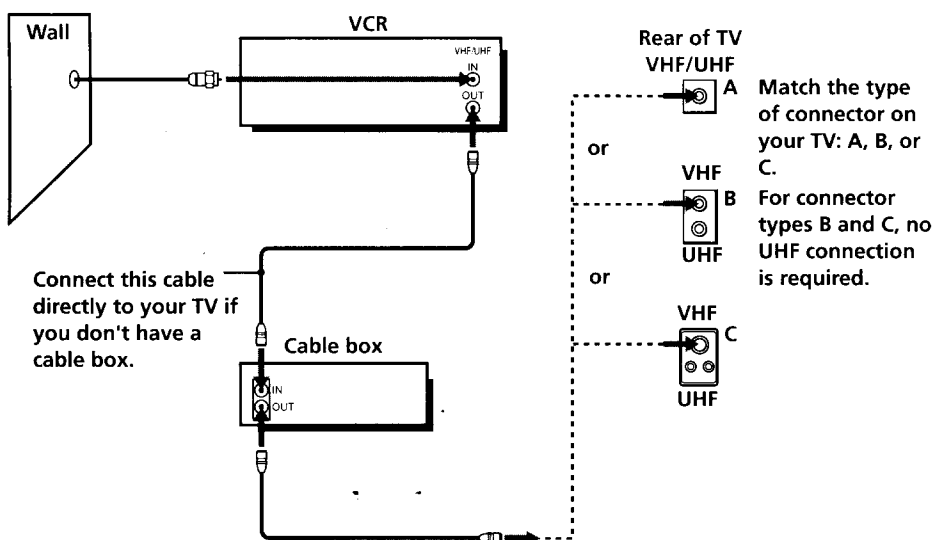

continued

Step 3: Hookups (continued)

Hookup 2: VCR setup

- 1 Set the RF UNIT switch to CH 3 or CH 4, whichever channel is not used in your area. If both are used, set the switch to either channel.

For details, see page 70.
If you made A/V connections (from page 8), you can skip this step.

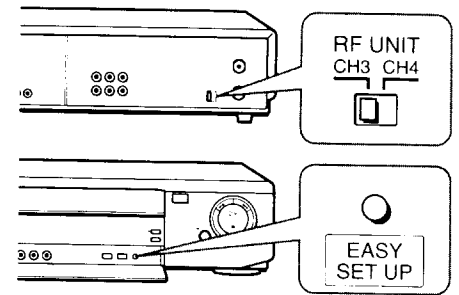

- 2 Press EASY SET UP on the VCR.
 - 1 The LANGUAGE menu appears. Change the on-screen display language to Spanish (ESPAÑOL) or French (FRANÇAIS) if desired, and press the Joystick (EXECUTE). For details, see page 30.

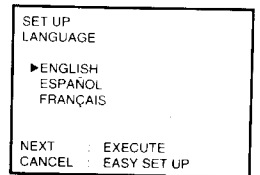

- 2 The CLOCK SET menu appears. Select AUTO and press the Joystick (EXECUTE). For details, see page 31.

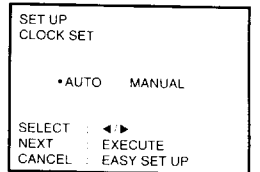

- 3 The CABLE BOX CONTROL menu appears. Select OFF and press the Joystick (EXECUTE). For details, see page 38.

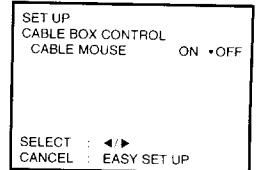

- 4 The TUNER PRESET menu appears. Set ANTENNA/CABLE to CABLE and press the Joystick (EXECUTE). For details, see page 43.

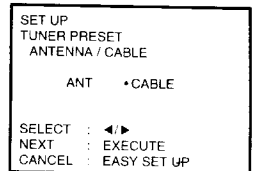

- 5 The AUTO PRESET starts.

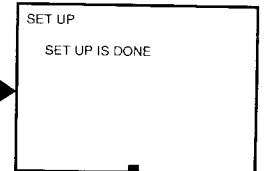
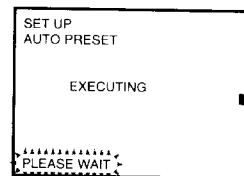

Normal display

Hookup 2: VCR Plus+ channel setup

- 1 Find the VCR Plus+ Channel Listing in your program guide. For details, see page 47.
- 2 If the channels in the program guide are different from the channels that you actually use on your TV, set the channels that are different as follows. For details, see page 48.

- 1 Press MENU and select SET VCR PLUS+ CHANNELS.

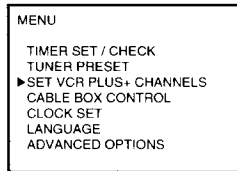

- 2 Enter the program guide channel, then the channel you use on your TV.

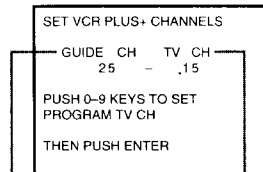

- 3 Press the Joystick (EXECUTE).

Program guide channel

Your actual TV channel

Getting Started

Automatic clock setting

Once you've set up the VCR, it automatically sets the clock the first time you turn off the VCR. After that, whenever you turn off the VCR, it checks the time and adjusts the clock, even for Daylight Saving Time. The VCR sets the clock by picking up a time signal provided by some TV channels.

If you want to use the timer to record right away, or if the channels in your area do not carry time signals, set the clock manually. For details, see pages 36 to 37.

Antenna hookup

Make the following connections if you're using an antenna (if you don't have cable TV).

A Use this hookup if you're using:

- VHF/UHF antenna (you get channels 2-13 and channels 14 and higher)
- UHF-only antenna (you get channels 14 and higher)
- Separate VHF and UHF antennas

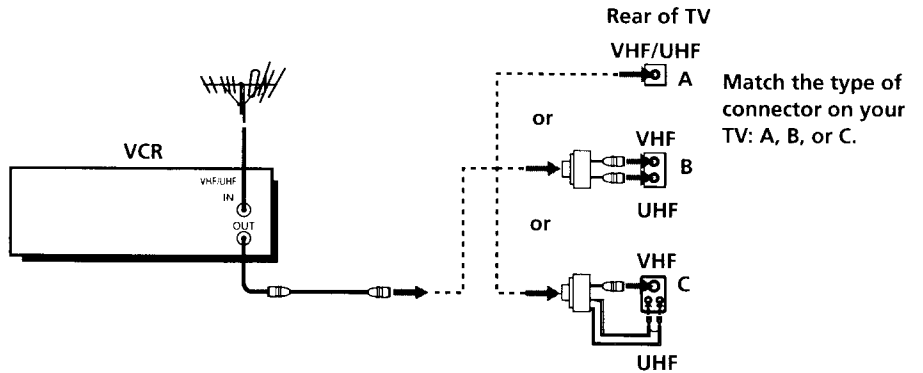

B Use this hookup if you're using a VHF-only antenna (you get channels 2-13 only)

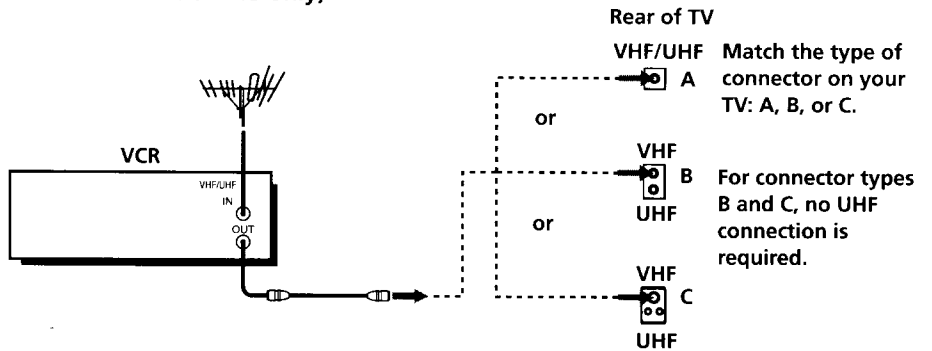

If you cannot connect your antenna cable to the VCR directly

If your antenna cable is a flat cable (300-ohm twin lead cable), attach an external antenna connector (not supplied) so that you can connect the cable to the VHF/UHF IN connector. If you have separate cables for VHF and UHF antennas, you should use a U/V band mixer (not supplied). For details, see page 71.

Hookup 3: VCR setup

- 1 Set the RF UNIT switch to CH 3 or CH 4, whichever channel is not used in your area. If both are used, set the switch to either channel.

For details, see page 70. If you made A/V connections (from page 8), you can skip this step.

- 2 Press EASY SET UP on the VCR.

- 1 The LANGUAGE menu appears. Change the on-screen display language to Spanish (ESPAÑOL) or French (FRANÇAIS) if desired, and press the Joystick (EXECUTE). For details, see page 30.

- 2 The CLOCK SET menu appears. Select AUTO and press the Joystick (EXECUTE). For details, see page 31.

- 3 The CABLE BOX CONTROL menu appears. Select OFF and press the Joystick (EXECUTE). For details, see page 38.

- 4 The TUNER PRESET menu appears. Set ANTENNA/CABLE to ANT and press the Joystick (EXECUTE). For details, see page 43.

- 5 The AUTO PRESET starts.

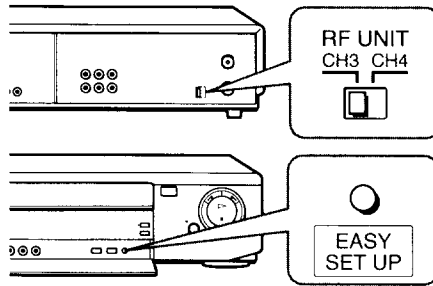

Getting Started

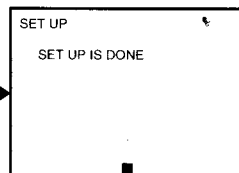
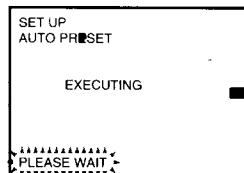
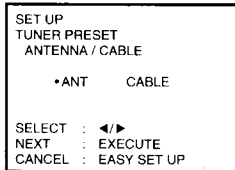
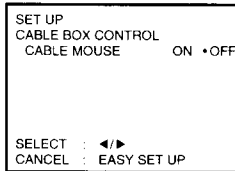
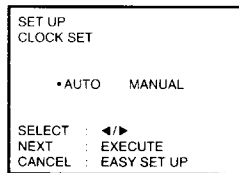
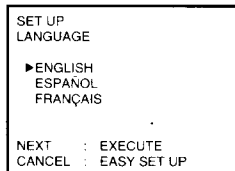

Normal display

continued

Step 3: Hookups (continued)

Hookup 3: VCR Plus+ channel setup

- 1 Find the VCR Plus+ Channel Listing in your program guide. For details, see page 47.
- 2 If the channels in the program guide are different from the channels that you actually use on your TV, set the channels that are different as follows. For details, see page 48.

- 1 Press MENU and select SET VCR PLUS+ CHANNELS.

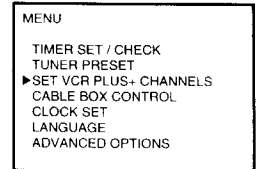

- 2 Enter the program guide channel, then the channel you use on your TV.

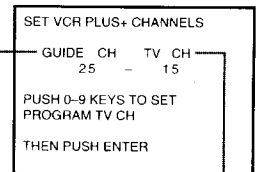

- 3 Press the Joystick (EXECUTE).

Program guide channel

Your actual TV channel

Automatic clock setting

Once you've set up the VCR, it automatically sets the clock the first time you turn off the VCR. After that, whenever you turn off the VCR, it checks the time and adjusts the clock, even for Daylight Saving Time. The VCR sets the clock by picking up a time signal provided by some TV channels.

If you want to use the timer to record right away, or if the channels in your area do not carry time signals, set the clock manually. For details, see pages 36 to 37.

Incompatible cable box with many scrambled channels

Recommended use

Use this hookup if your cable company cannot supply a cable box that is compatible with the VCR's cable box control feature, and your cable system scrambles all or most channels.

What you can do with this hookup

- Record any channel by selecting the channel on the cable box

What you can't do

- Record with the cable box turned off
- Record one channel while watching another channel
- Select channels directly on the VCR

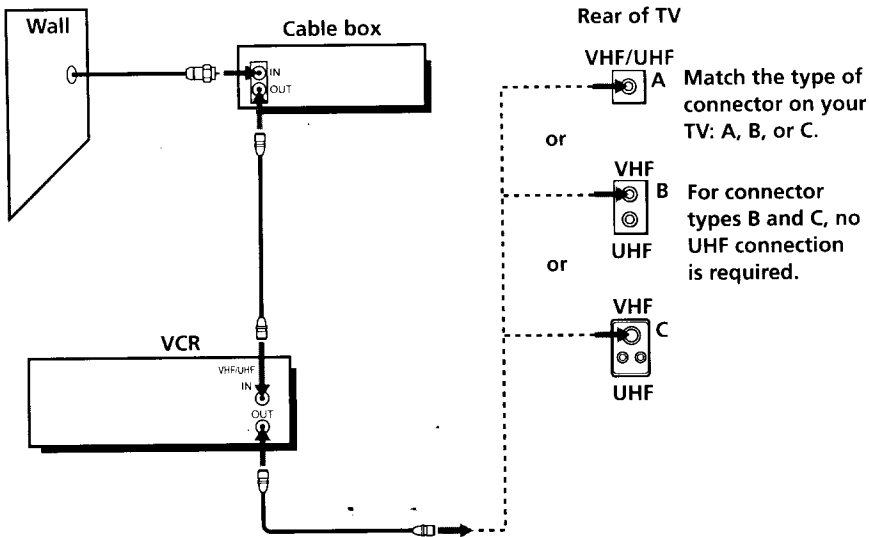

continued

Hookup 4: VCR setup

- 1 Set the RF UNIT switch to CH 3 or CH 4, whichever channel is not used in your area. If both are used, set the switch to either channel.

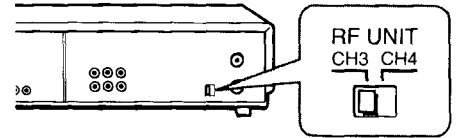

For details, see page 70. If you made A/V connections (from page 8), you can skip this step.

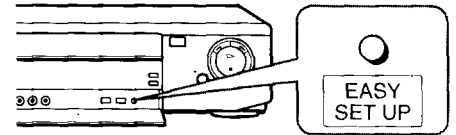

- 2 Turn on your cable box.
- 3 Press EASY SET UP on the VCR.

- 1 The LANGUAGE menu appears. Change the on-screen display language to Spanish (ESPAÑOL) or French (FRANÇAIS) if desired, and press the Joystick (EXECUTE). For details, see page 30.

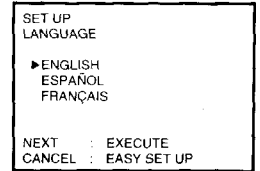

- 2 The CLOCK SET menu appears. Select AUTO and press the Joystick (EXECUTE). For details, see page 31.

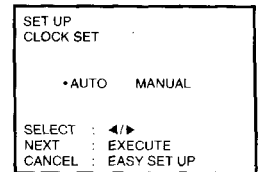

- 3 The CABLE BOX CONTROL menu appears. Select OFF and press the Joystick (EXECUTE). For details, see page 38.

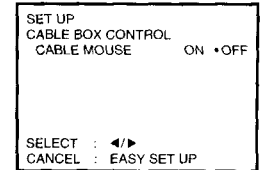

- 4 The TUNER PRESET menu appears. Set ANTENNA/CABLE to ANT and press the Joystick (EXECUTE). For details, see page 43.

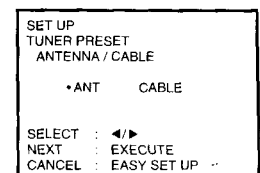

- 5 The AUTO PRESET starts.

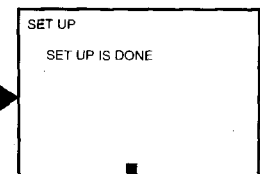
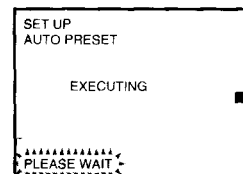

Normal display

Hookup 4: VCR Plus+ channel setup

- 1 Find the VCR Plus+ Channel Listing in your program guide. For details, see page 47.
- 2 Enter all the channels you want to record and the cable box output channel (usually 2, 3, or 4). For details, see page 48.

- 1 Press MENU and select SET VCR PLUS+ CHANNELS.

```
MENU
TIMER SET / CHECK
TUNER PRESET
▶SET VCR PLUS+ CHANNELS
CABLE BOX CONTROL
CLOCK SET
LANGUAGE
ADVANCED OPTIONS
```

- 2 Enter the program guide channel, then the cable box output channel.

```
SET VCR PLUS+ CHANNELS
GUIDE CH  TV CH
  33     -   3
PUSH 0-9 KEYS TO SET
PROGRAM TV CH
THEN PUSH ENTER
```

- 3 Press the Joystick (EXECUTE).

Program guide channel

Cable box output channel

Getting Started

Automatic clock setting

To use the Auto Clock Set feature with this hookup, you need to manually select a channel that carries a time signal:

- 1 Tune the cable box to a channel that carries a time signal.
- 2 Select AUTO in the CLOCK SET menu to turn on the Auto Clock Set feature.
- 3 Turn off the VCR. It automatically sets the clock and adjusts for Daylight Saving Time by picking up the time signal.

If you want to use the timer to record right away, or if the channels in your area do not carry time signals, set the clock manually. For details, see pages 36 to 37.

Note

- To use the automatic clock setting feature, leave the cable box on.

continued

DSS (Digital Satellite System) receiver

Recommended use

Use this hookup if you have a DSS receiver. It allows the VCR's cable box control feature to control the channel on the DSS receiver, simplifying the recording process. A list of compatible DSS receivers is on page 40.

DSS (Digital Satellite System) is a satellite broadcast that provides superior digital-quality video and crisp digital-quality audio. A variety of program packages are available through your program providers. It also has program guides that are sorted by program categories.

What you can do with this hookup

- Record any channels using the VCR's cable box control feature to select channels on the DSS receiver.

What you can't do

- Record with the DSS receiver turned off
- Record any channels from cable or an antenna
(To record channels from cable or an antenna, turn off the cable box control feature.)
- Use a cable box
- Record programs with VCR Plus+

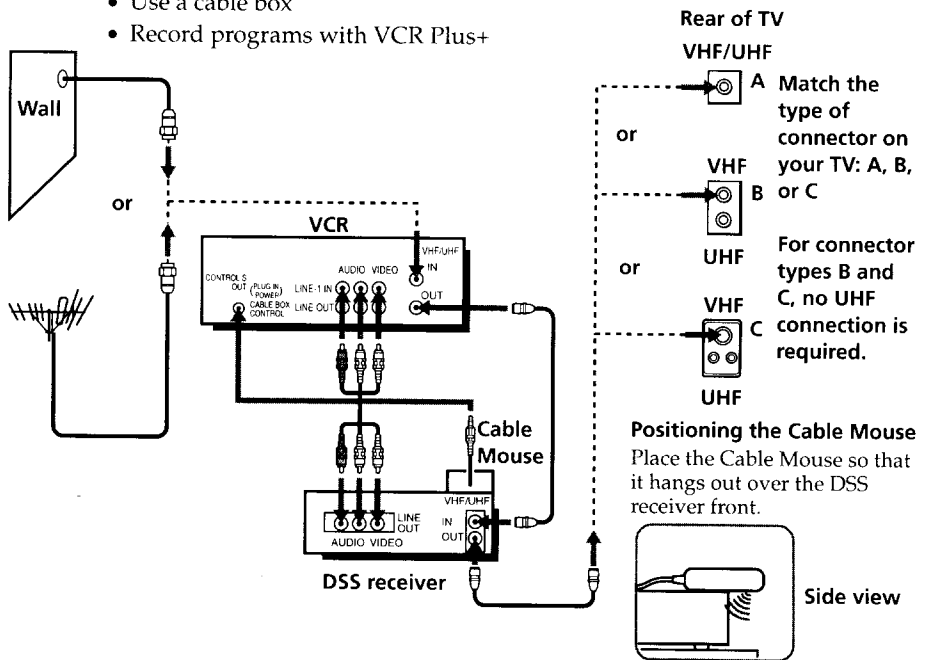

Hookup 5: VCR setup

- 1** Set the RF UNIT switch to CH 3 or CH 4, whichever channel is not used in your area. If both are used, set the switch to either channel.

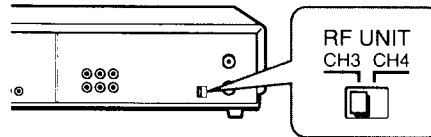

For details, see page 70. If you made A/V connections (from page 8), you can skip this step.

- 2** Turn on your DSS receiver.
3 Press EASY SET UP on the VCR.

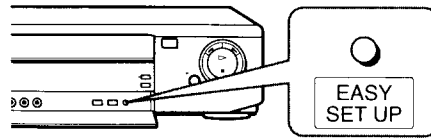

- 1** The LANGUAGE menu appears. Change the on-screen display language to Spanish (ESPAÑOL) or French (FRANÇAIS) if desired, and press the Joystick (EXECUTE). For details, see page 30.

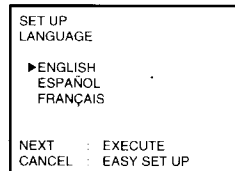

- 2** The CLOCK SET menu appears. Select MANUAL and press the Joystick (EXECUTE). For details, see page 36.

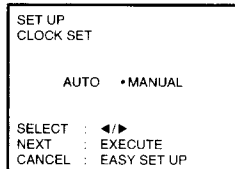

- 3** The CABLE BOX CONTROL menu appears. Select ON. For details, see page 38.

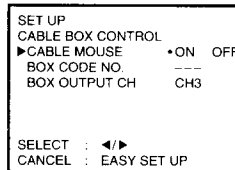

- 4** Enter your DSS receiver code number and push Joystick to ↓. For details, see page 38.

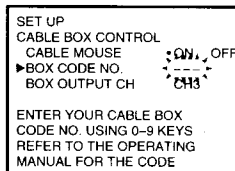

- 5** Set your DSS receiver output channel (BOX OUTPUT CH) to LINE and press the Joystick (EXECUTE).

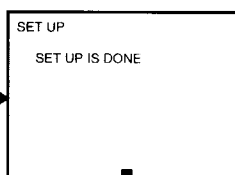
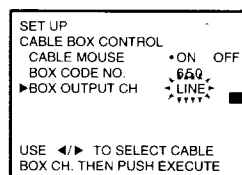

Normal display

Step 3: Hookups (continued)

Automatic clock setting

Once you've set up the VCR, it automatically sets the clock the first time you turn off the VCR. After that, whenever you turn off the VCR, it checks the time and adjusts the clock, even for Daylight Saving Time. The VCR sets the clock by picking up a time signal provided by some TV channels.

If you want to use the timer to record right away, or if the channels in your area do not carry time signals, set the clock manually. For details, see pages 36 to 37.

Note

- To successfully record a program from the DSS receiver, proceed as follows:
 - Leave the DSS receiver on all the time.
 - Turn off the display (menu screen, channel number, etc.) of the DSS receiver.
 - To record or receive locked channels, unlock the channel before the VCR starts recording.
 - To set pay-per-view programs in the timer setting, order the pay-per-view program before the VCR starts recording.
 - Some programs are copy protected. You cannot record these programs.

Incompatible cable box with only a few scrambled channels, using an A/B switch

Recommended use

By using an A/B switch (not supplied), this hookup allows you to record both scrambled and unscrambled channels conveniently.

What you can do with this hookup

- Record any unscrambled channel by selecting the channel directly on the VCR (the A/B switch is set to A)
- Record any scrambled channel by selecting the channel on the cable box (the A/B switch is set to B)

What you can't do

- Record one scrambled channel while watching another channel (the A/B switch is set to B)

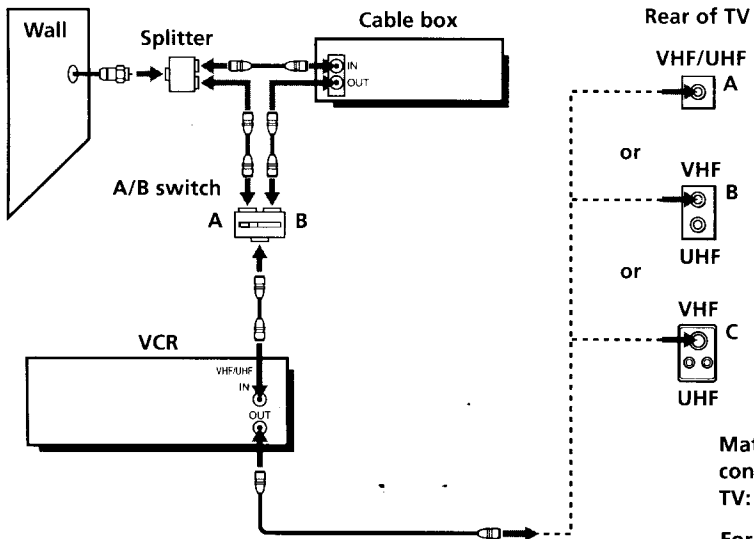

Match the type of connector on your TV: A, B, or C.

For connector types B and C, no UHF connection is required.

continued

Step 3: Hookups (continued)

Hookup 6: VCR setup

- 1 Set the RF UNIT switch to CH 3 or CH 4, whichever channel is not used in your area. If both are used, set the switch to either channel.

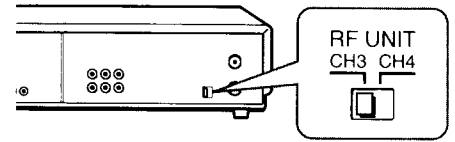

For details, see page 70. If you made A/V connections (from page 8), you can skip this step.

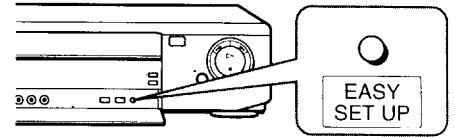

- 2 Set the A/B switch to "A."
- 3 Press EASY SET UP on the VCR.

- 1 The LANGUAGE menu appears. Change the on-screen display language to Spanish (ESPAÑOL) or French (FRANÇAIS) if desired, and press the Joystick (EXECUTE). For details, see page 30.

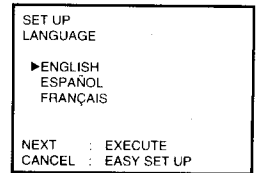

- 2 The CLOCK SET menu appears. Select AUTO and press the Joystick (EXECUTE). For details, see page 31.

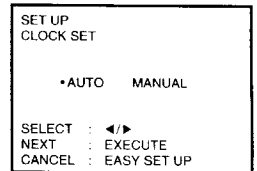

- 3 The CABLE BOX CONTROL menu appears. Select OFF and press the Joystick (EXECUTE). For details, see page 38.

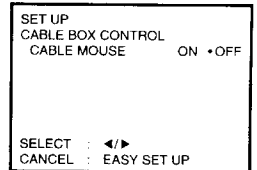

- 4 The TUNER PRESET menu appears. Set ANTENNA/CABLE to CABLE and press the Joystick (EXECUTE). For details, see page 43.

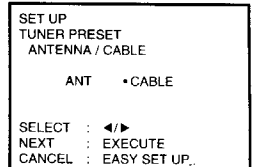

- 5 The AUTO PRESET starts.

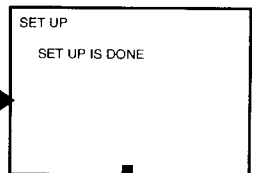
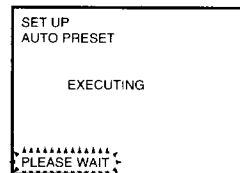

Normal display

4 Preset the cable box output channel (usually 2, 3 or 4). For details, see page 45.

❶ Press MENU and select TUNER PRESET.

❷ Enter the cable box output channel.

❸ Set MANUAL SET to ADD and press the Joystick (EXECUTE).

Cable box output channel

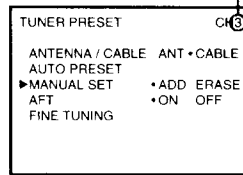

Getting Started

continued

Step 3: Hookups (continued)

Hookup 6: VCR Plus+ channel setup

- 1 Find the VCR Plus+ Channel Listing in your program guide. For details, see page 47.
- 2 For unscrambled channels, if the channels in the program guide are different from the channels that you actually use on your TV, set the channels that are different as follows. For details, see page 48.

- 1 Press MENU and select SET VCR PLUS+ CHANNELS.

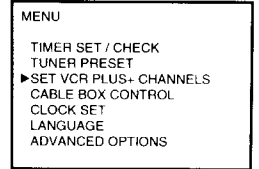

- 2 Enter the program guide channel, then the channel you use on your TV.

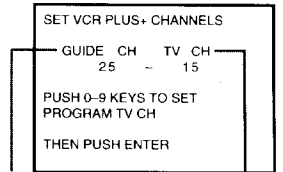

Program guide channel

Your actual TV channel

- 3 Press the Joystick (EXECUTE).

- 3 For scrambled channels, enter all the scrambled channels you want to record and the cable box output channel (usually 2, 3, or 4). For details, see page 48.

- 1 Press MENU and select SET VCR PLUS+ CHANNELS.

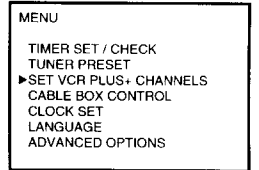

- 2 Enter the program guide channel, then the cable box output channel.

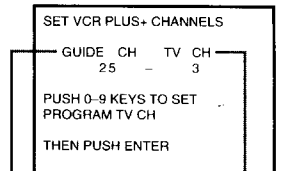

Program guide channel

Cable box output channel

- 3 Press the Joystick (EXECUTE).

Automatic clock setting

Once you've set up the VCR, it automatically sets the clock the first time you turn off the VCR. After that, whenever you turn off the VCR, it checks the time and adjusts the clock, even for Daylight Saving Time. The VCR sets the clock by picking up a time signal provided by some TV channels.

If you want to use the timer to record right away, or if the channels in your area do not carry time signals, set the clock manually. For details, see pages 36 to 37.



Note

- To use the automatic clock setting feature, set the A/B switch to A.

Selecting a language

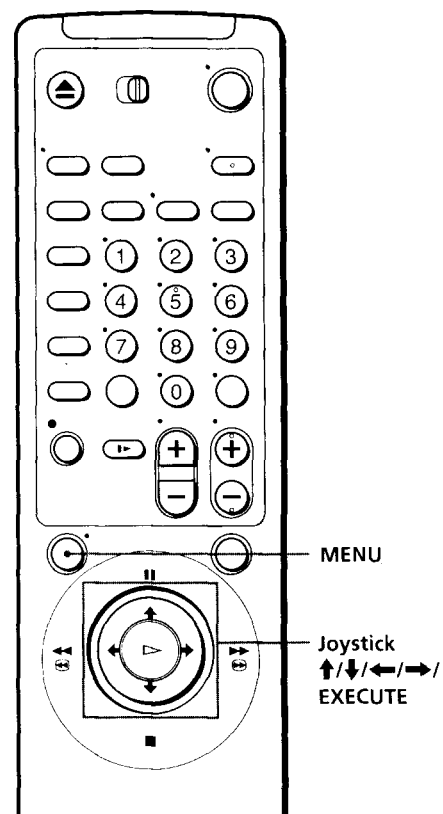
You can change the on-screen display language.



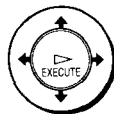

- 1**  Press MENU, then push Joystick to  to move the cursor () to LANGUAGE and press the Joystick (EXECUTE).

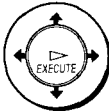

When using the EASY SET UP procedure, skip this step.

LANGUAGE
▶ ENGLISH
ESPAÑOL
FRANÇAIS

- 2**  Push Joystick to  to select ENGLISH, ESPAÑOL, or FRANÇAIS, then press the Joystick (EXECUTE).

Setting the clock

Using the Auto Clock Set feature

Some TV and cable channels transmit time signals with their broadcasts. Your VCR can pick up this time signal to automatically set the clock.

The Auto Clock Set feature works only if a channel in your area is broadcasting a time signal. If broadcasters in your area are not yet sending time signals, set the time manually (page 36).

Before you start...

- Turn on the VCR and the TV.
- Set the TV to the VCR channel (channel 3 or 4). If your TV is connected to the VCR using A/V connections, set the TV to video input.
- Press TV/VTR to display the VTR indicator in the VCR's display window.
- Press INPUT SELECT so that a channel number appears in the VCR's display window.

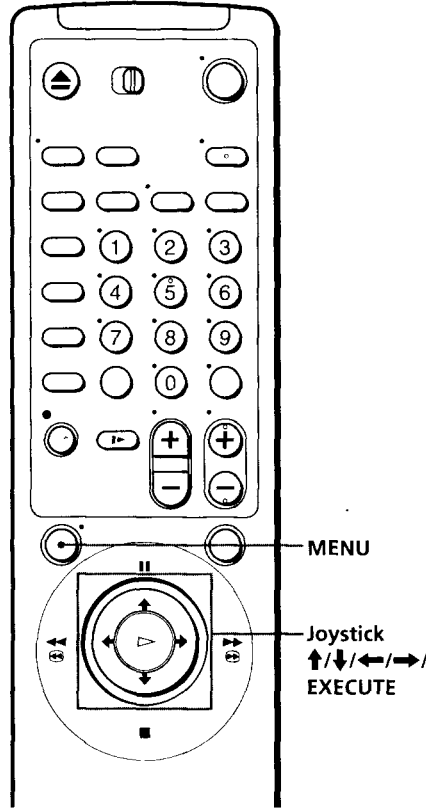

Getting Started

1

Press MENU, then push Joystick to \uparrow/\downarrow to move the cursor (\blacktriangleright) to CLOCK SET and press the Joystick (EXECUTE).

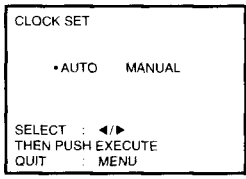

2

Push Joystick to \leftarrow/\rightarrow to select AUTO, then press the Joystick (EXECUTE).

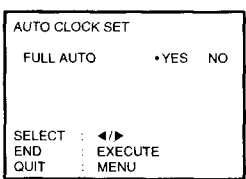

continued

Setting the clock (continued)

3

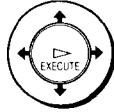

Push Joystick to ←/→ to select YES, then press the Joystick (EXECUTE).

4

To activate the Auto Clock Set function, turn off the VCR.

The VCR automatically sets the clock by searching for a channel that carries a time signal and sets your time zone and Daylight Saving Time (if applicable).

If your clock is set to the wrong time zone or Daylight Saving Time, you can adjust these settings without turning off the Auto Clock Set feature (page 33).

Notes

- The clock cannot be set automatically if you don't receive a channel that carries a time signal in your area. If so, set the clock manually.
- If there are only a few channels in your area that carry time signals, setting the clock automatically may take up to about 30 minutes. If nothing happens even after you wait about 30 minutes, set the clock manually.
- If you use Hookup 1 or Hookup 4, make sure you leave the cable box on.

If the clock is not activated

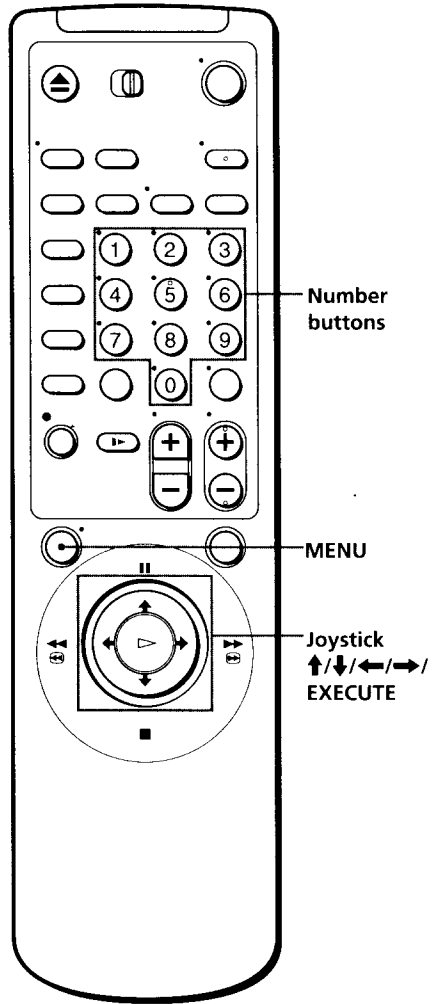

Getting Started

1

Follow steps 1 and 2 in "Using the Auto Clock Set feature."
The AUTO CLOCK SET menu is displayed.

AUTO CLOCK SET	
▶FULL AUTO	YES •NO
CLOCK SET CH	---
TIME ZONE	AUTO
DAYLIGHT SAVING	AUTO
SELECT :	◀/▶
END :	EXECUTE
QUIT :	MENU

continued

Setting the clock (continued)

2

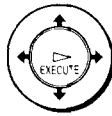

Push Joystick to ←/→ to select NO for FULL AUTO.

AUTO CLOCK SET	
▶FULL AUTO	YES •NO
CLOCK SET CH	---
TIME ZONE	AUTO
DAYLIGHT SAVING	AUTO
SELECT	◀/▶
END	EXECUTE
QUIT	MENU

3

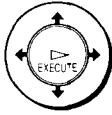

Push Joystick to ↑/↓ to move the cursor (▶) to the item you want to set, then push Joystick to ←/→ to make the setting.

- For CLOCK SET CH
Leave the setting to "--" to have the VCR automatically search for a channel that carries a time signal.

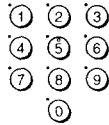

Press the number buttons to select a channel that carries a time signal.

Use this option if you know of a channel that carries a time signal. Most PBS member stations broadcast a time signal. For the fastest response, select your local PBS station.

- For TIME ZONE

Select the time zone of your area, or select AUTO to have the VCR automatically set your time zone.

The options are: AUTO → ATLANTIC → EASTERN → CENTRAL → MOUNTAIN → PACIFIC → ALASKA → HAWAII → AUTO

- For DAYLIGHT SAVING

Select ON or OFF (standard time), or AUTO to have the VCR automatically set the daylight saving time.

AUTO CLOCK SET	
FULL AUTO	YES •NO
▶CLOCK SET CH	122
TIME ZONE	AUTO
DAYLIGHT SAVING	AUTO
USE	0-9
END	EXECUTE
QUIT	MENU

AUTO CLOCK SET	
FULL AUTO	YES •NO
CLOCK SET CH	122
▶TIME ZONE	AUTO
DAYLIGHT SAVING	AUTO
SELECT	◀/▶
END	EXECUTE
QUIT	MENU

AUTO CLOCK SET	
FULL AUTO	YES •NO
CLOCK SET CH	122
TIME ZONE	AUTO
▶DAYLIGHT SAVING	AUTO
SELECT	◀/▶
END	EXECUTE
QUIT	MENU

4

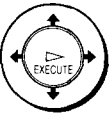

Press the Joystick (EXECUTE).

5

To activate the Auto Clock Set function, turn off the VCR.

Note

- If you use both the cable box control feature and the Auto Clock Set feature, the VCR automatically changes channels on the cable box until a channel that carries a time signal is found, whenever you turn off the VCR. If you want to stop the search, change the channel on the cable box with the channel buttons either on the VCR or on the remote commander.

continued

Setting the clock (continued)

Using Manual clock set

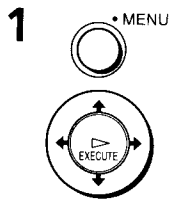
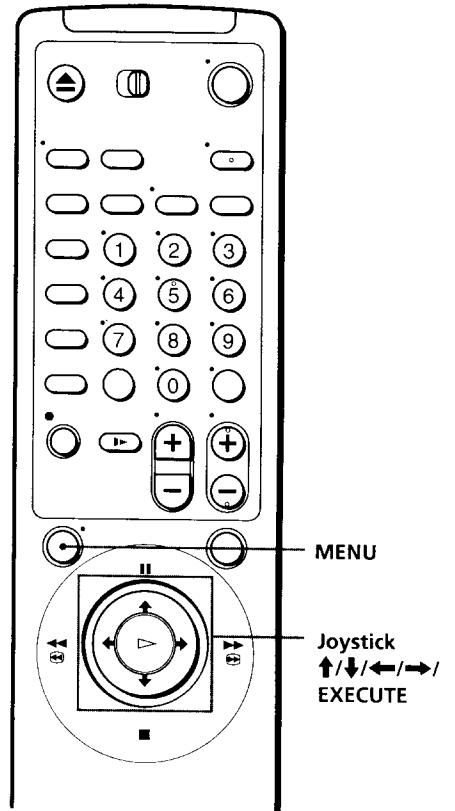

Press MENU, then push Joystick to ↑/↓ to move the cursor (▶) to CLOCK SET and press the Joystick (EXECUTE).

When using the EASY SET UP procedure, skip this step.

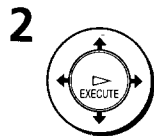
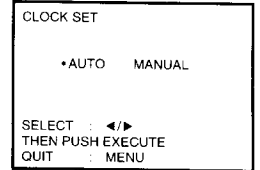

Push Joystick to ←/→ to select MANUAL and press the Joystick (EXECUTE).

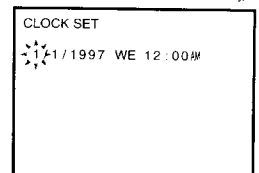

3

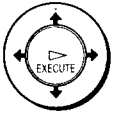

Push Joystick to **↑/↓** to set the month.

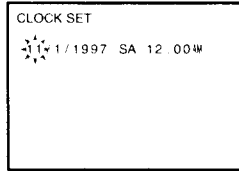

4

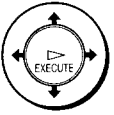

Push Joystick to **→** to flash the day and push Joystick to **↑/↓** to set the day. The day of the week is set automatically.

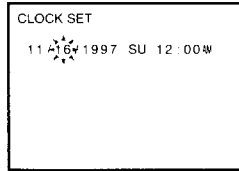

5

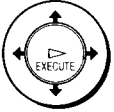

Set the year, hour and minutes in the same way as the day.

6

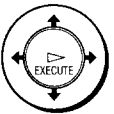

Press the Joystick (EXECUTE) to start the clock.

Getting Started

Setting up cable box control

(Skip this section if you are using Hookup 2, 3, 4, or 6.)

Your VCR includes a cable box control feature that allows the VCR to control most brands of cable boxes/DSS receivers via the Cable Mouse. With cable box control, the VCR controls channels on the cable box/DSS receiver for timer recording. You can also use the VCR's remote commander to change channels on the cable box/DSS receiver whenever the cable box/DSS receiver is turned on even if the VCR is turned off. To use cable box control, you need to connect the Cable Mouse (pages 10 and 22) and set the code number and output channel.

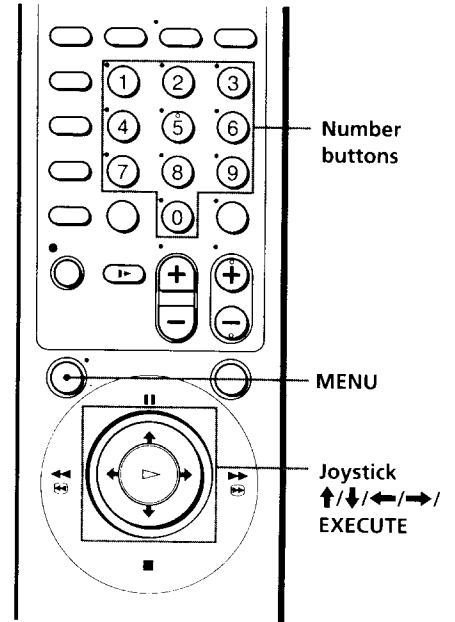

This VCR is programmed with codes necessary to control channel selection on most brands of cable boxes at the time this VCR was manufactured. It is possible that new cable boxes may be introduced that cannot be controlled with this VCR's Cable Mouse. If you have a cable box that is incompatible with this VCR, contact your cable operator — they may be able to provide you with a compatible cable box.

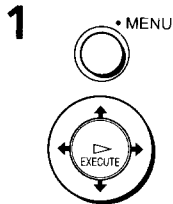

Press MENU, then push Joystick to ↑/↓ to move the cursor (▶) to CABLE BOX CONTROL and press the Joystick (EXECUTE).

When using the EASY SET UP procedure, skip this step.

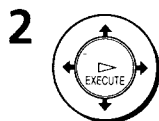
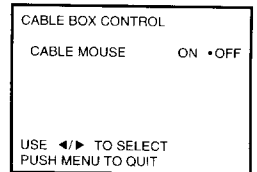

Push Joystick to ←/→ to select ON, then push Joystick to ↓.

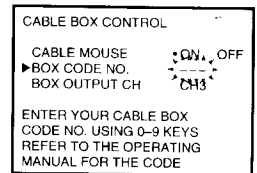

3

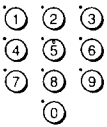

Press the number buttons to enter the cable box/DSS receiver code number, then push Joystick to ↓.

Find your cable box/DSS receiver code number from the chart below.

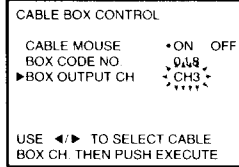
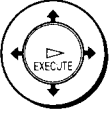

4

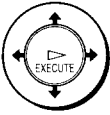

If you want to control a cable box, push Joystick to ←/→ to select the output channel for the cable box, then press the Joystick (EXECUTE).

If you want to control a DSS receiver, select LINE, then press the Joystick (EXECUTE).

Getting Started

Cable box and DSS receiver brand and the corresponding code numbers

If more than one code number is listed, try entering them one by one, until you come to the correct code for your equipment.

Cable box brand	Code numbers
ABC	018, 022, 024, 028, 217
Antronix	218
Archer	033, 050, 164, 218
BBT	278
Cable Star	067
Cabletenna	033
Cable time	172, 282, 388, 459
Century	164
Citizen	164, 326, 327
Clyde Cablevision	097
Colour Voice	036, 042
Comband	243, 244
Comtronics	051, 071
Decsat	434
Diamond	046
Eagle Comtronics	051

Cable box brand	Code numbers
Eastern	013, 285
Electricord	089
Electus	055
Filmnet	454
Focus	411
Garrard	164
GC Electronics	027, 067, 341
GE	243, 244
GEC	097
Gemini	026, 068, 081, 253
General Instrument	022, 287, 487
Hamlin	020, 031, 045, 270, 284
Hitachi	022
Jasco	164, 326
Jerrold	014, 022, 025, 026, 035, 037, 058, 109, 287, 487

continued

Setting up cable box control (continued)

Cable box brand	Code numbers
Linsay	451
Macom	044
Magnavox	038, 043, 080, 345
Memorex	011
Movie Time	089, 167, 214
Northcoast	325
Novaplex	629
NSC	074, 081, 167, 214
Oak	018, 030, 259
Omniview	382
Panasonic	032, 118
Paragon	011
Philips	036, 038, 039, 040, 041, 042, 071, 301, 345
Philips ECG	253
Pioneer	034, 155, 271, 544, 695
Popular Mechanics	411
Pulsar	011
RCA	032
Realistic	218
Recoton	411
Regal	031, 270, 284, 290
Regency	013
Rembrandt	081
RK	315, 317, 490
Samsung	051, 155
Satbox	386
Scientific Atlanta	017, 019, 028, 288, 338
Seam	521
Sharp	324
Signal	051
Signature	022
SL Marx	051
Spectravision	069
Sprucer	032, 318
Standard Components	107, 166
Starcom	014, 026, 058, 109

Cable box brand	Code numbers
Stargate	026, 051
STS	167
Sylvania	012
T-Cable Teletext	116
Tandy	269
Tatung	108
Teknica	157
Tele +1	454
TeleCaption	232
Teleservice	292
Texscan	012, 107
TFC	321
Timeless	429
Tocom	023, 024, 070
Toshiba	011
Tudi	297
TV86	074
TV COM	018, 030, 259
Uniden	236
Unika	033, 164, 218
United Artists	018
United Cable	014
Universal	033, 050, 067, 088, 089, 164, 202, 218, 333
Videoway	261
Vidtech	255
Viewstar	038, 071, 074, 122, 222, 269, 300
Westminster cable	116
Zenith	011, 065, 536
Zentek	411
Wave Master	576

DSS receiver brand	Code numbers
Sony	650
RCA	577

To ensure correct operation

- Place the Cable Mouse so that it hangs out over the cable box/DSS receiver front.
- Do not place the cable box/DSS receiver on top of the VCR.
- Position the cable box/DSS receiver away from the VCR.
- Point the remote commander at the VCR, not at the cable box/DSS receiver.

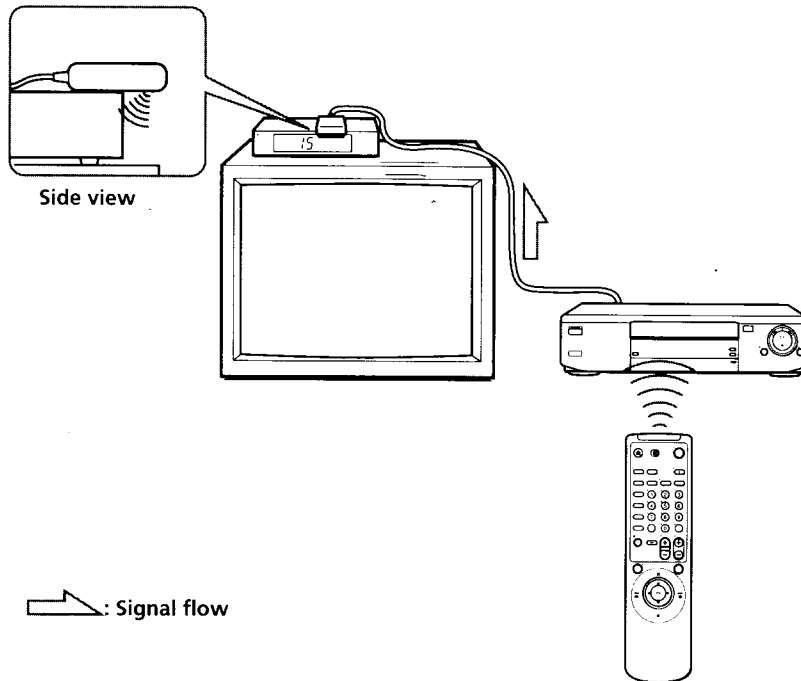

Getting Started

To check the cable box control setting

- 1** Press CH +/- on the remote commander. Does the channel indicator on the cable box/DSS receiver change? (Point the remote commander at the VCR, not at the cable box/DSS receiver.)
- 2** Press all 10 number buttons (0 to 9) on the remote commander. Does the channel indicator on the cable box/DSS receiver change?

If the answer to both 1 and 2 is "yes," you have made the correct setting.

continued

Setting up cable box control (continued)

If you cannot get your VCR to control the cable box/DSS receiver

- Check that the Cable Mouse is connected to the CABLE BOX CONTROL jack on the VCR.
- Check the position of the Cable Mouse.
- Place the cable box/DSS receiver and VCR away from each other. Do not place the cable box/DSS receiver on top of the VCR.
- Try the setup again making sure to use the correct control code. If the cable box still does not respond, try the other codes that are listed.

If your cable box still does not operate with the Cable Mouse, contact your cable company to see if they can provide you with a compatible cable box.

Note

- Make sure you turn off the VCR when you plug in or unplug the Cable Mouse. If you unplug the Cable Mouse and plug it in again, turn on the VCR before you use the cable box/DSS receiver control feature.

Presetting channels

(Skip this section if you are using cable box/DSS receiver control.)

This VCR is capable of receiving VHF channels 2 to 13, UHF channels 14 to 69 and unscrambled CATV channels 1 to 125. First, we recommend that you preset the receivable channels in your area using automatic presetting. Then, if there are any unwanted channels, disable them manually. If you have decided which channels you wish to preset, set them directly using manual presetting.

Before you start...

- Turn on the VCR and the TV.
- Set the TV to the VCR channel (channel 3 or 4). If your TV is connected to the VCR using A/V connections, set the TV to video input.
- Press TV/VTR to display the VTR indicator in the VCR's display window.

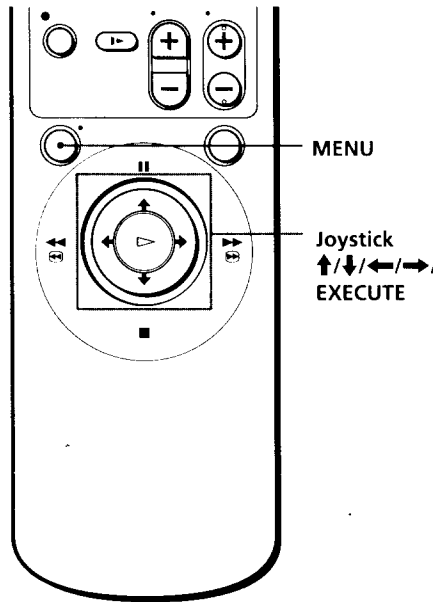

Getting Started

Presetting all receivable channels automatically

1  Press MENU, then push Joystick to ↑/↓ to move the cursor (▶) to TUNER PRESET and press the Joystick (EXECUTE).

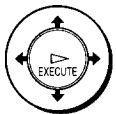

When using the EASY SET UP procedure, skip this step.

TUNER PRESET	CH1
ANTENNA / CABLE	ANT • CABLE
AUTO PRESET	
▶ MANUAL SET	• ADD ERASE
AFT	• ON OFF
FINE TUNING	

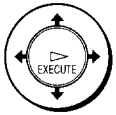
2  Push Joystick to ↑/↓ to select ANTENNA/CABLE.

continued

Presetting channels (continued)

3

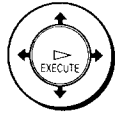

• To preset cable TV channels:

Push Joystick to ←/→ to set ANTENNA/CABLE to CABLE.

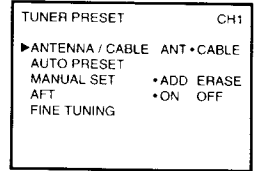

• To preset VHF and UHF channels:

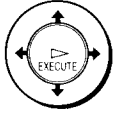

Push Joystick to ←/→ to set ANTENNA/CABLE to ANT.

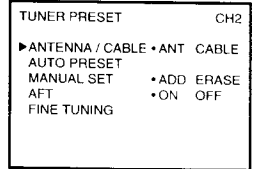

4

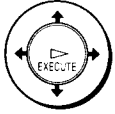

Push Joystick to ↑/↓ to select AUTO PRESET, then press the Joystick (EXECUTE).

All receivable channels are preset in numerical sequence. When no more receivable channels can be found, presetting stops and the picture from the lowest numbered channel is displayed on the TV screen.

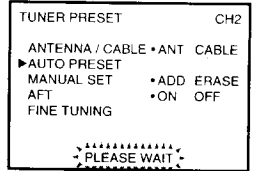

Presetting/disabling channels manually

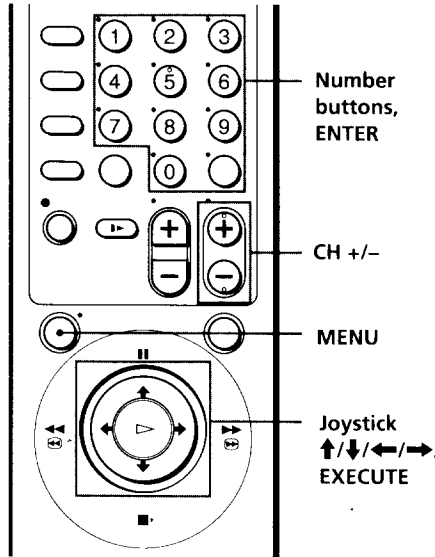

Getting Started

- 1** Press MENU and select TUNER PRESET, then press the Joystick (EXECUTE).

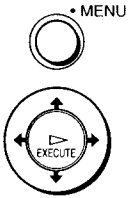

TUNER PRESET	CH1
ANTENNA / CABLE	ANT • CABLE
AUTO PRESET	
▶MANUAL SET	•ADD ERASE
AFT	•ON OFF
FINE TUNING	

- 2**
- To preset a channel:
 - 1 Press the number buttons to enter the channel number, then press ENTER.
 - 2 Push Joystick to ←/→ to set MANUAL SET to ADD.

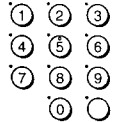

Channel to be preset

TUNER PRESET	CH1
ANTENNA / CABLE	ANT • CABLE
AUTO PRESET	
▶MANUAL SET	•ADD ERASE
AFT	•ON OFF
FINE TUNING	

- To disable a channel:
 - 1 Press CH +/- to select the channel number.
 - 2 Push Joystick to ←/→ to set MANUAL SET to ERASE.



Channel to be disabled

TUNER PRESET	CH1
ANTENNA / CABLE	ANT • CABLE
AUTO PRESET	
▶MANUAL SET	•ADD ERASE
AFT	•ON OFF
FINE TUNING	

- 3** Repeat step 2 to preset or disable channels as required, then press the Joystick (EXECUTE).

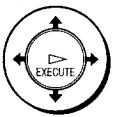

continued

Presetting channels (continued)

If the picture is not clear

Normally, the Auto Fine Tuning (AFT) function automatically tunes in channels clearly. If, however, the picture of a channel is not clear, you can also use the manual tuning function.

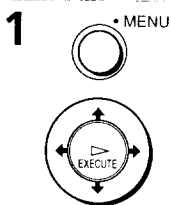
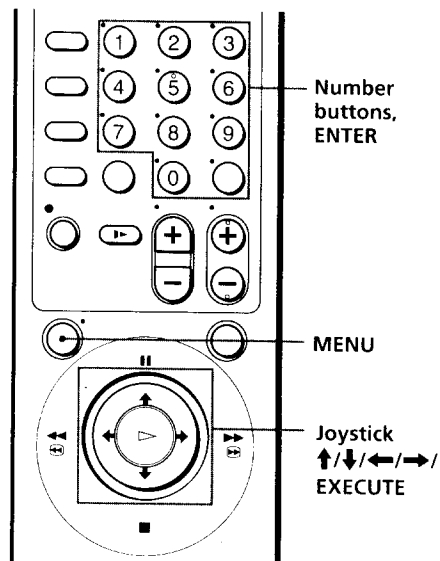

Press MENU and select TUNER PRESET, then press the Joystick (EXECUTE).

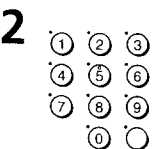
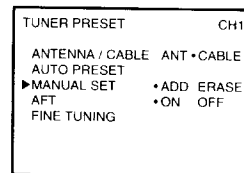

Press the number buttons to select the channel you want to fine-tune, then press ENTER.

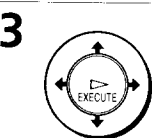
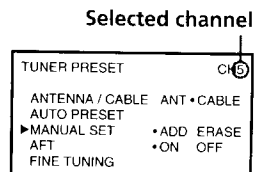

Push Joystick to ↑/↓ to select FINE TUNING.

The fine tuning meter appears.

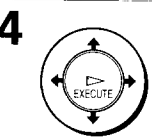
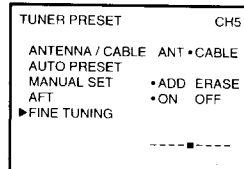

Push Joystick to ←/→ to adjust to a clearer picture, then press the Joystick (EXECUTE).

Note that the AFT setting switches to OFF.

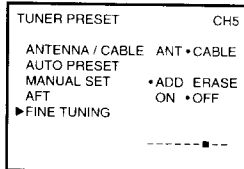

Setting up VCR Plus+

How VCR Plus+ works

Whenever you want to record a TV program, all you need to do is look up the program's "PlusCode," a number assigned to each program that's published in the TV section of most newspapers, cable TV listings, and even *TV GUIDE* magazine. Then, just enter the PlusCode of the program you want and the VCR is automatically programmed to record that show. It's that simple.

Example of "PlusCode"

		PlusCode
5:30	14 MOVIE — Musical (2hrs.)	33044
	2 SPORT — Golf (1hr. 25min.)	42060
	CNN — WS 9974	
6:30	2 3 4 DRAMA — Comedy (2hrs.)	17390
	5 SCIENCE AND TECHNOLOGY (1hr. 15min.)	73457

Getting Started

How to set up your VCR

Setting up your VCR involves coordinating the TV channel number (the number you turn to on your TV or VCR to watch a program) with the guide channel (the number that's assigned to that channel in your program guide). To get the guide channel numbers, find the "Channel Line-up Chart" in the program guide for your area that features VCR PlusCodes. It usually looks like the example to the right.

For each channel your VCR receives, use the Channel Line-up Chart to check that the channel numbers match. For example, if HBO is listed in the Channel Line-up Chart on channel 33, and your VCR receives HBO on channel 5, you need to coordinate these numbers using the following procedure. For channels in which the numbers are the same, you can skip this procedure.

Example of "Channel Line-up Chart"

CABLE CH	CABLE TV	VCR Plus+ GUIDE CH
16	AMC American Movie Classics	35
17	BRV Bravo (program grid only)	54
20	CNN Cable News Network	42
21	CSP C-SPAN	28
22	DIS The Disney Channel	53
25	DSC The Discovery Channel	37
34	ESN ESPN	34
35	FAM The Family Channel	47
5	HBO Home Box Office	33
27	LIF Lifetime	46
29	MAX Cinemax	45
30	MTV Music Television	48
31	NIK Nickelodeon	38
38	SC Sports Channel	59
39	SCA Sports Channel America	70
45	SHO Showtime	41
17	TBS TBS SuperStation	43
44	TMC The Movie Channel	58
49	TNN The Nashville Network	49
50	TNT Turner Network Television	52
51	USA USA Network	44

continued

Setting up VCR Plus+ (continued)

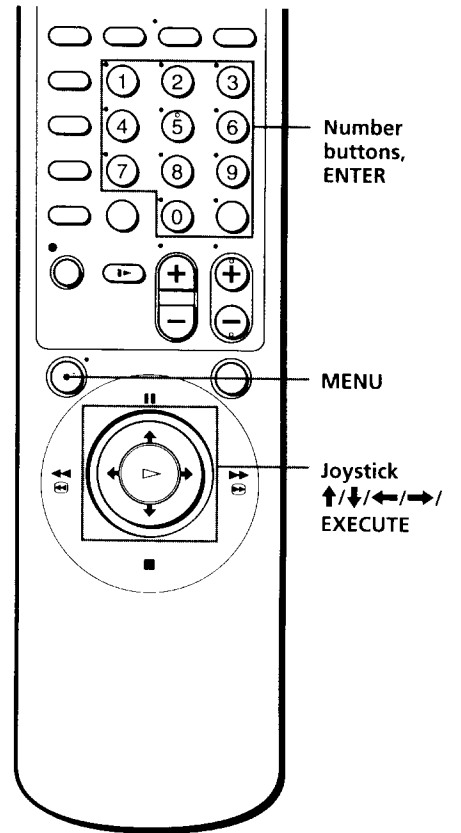

1

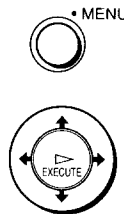

Press MENU, then push Joystick to \uparrow/\downarrow to move the cursor (\blacktriangleright) to SET VCR PLUS+ CHANNELS and press the Joystick (EXECUTE).

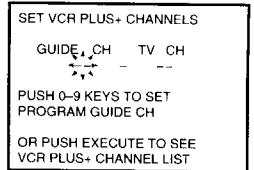

2

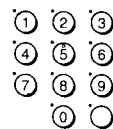

Enter the channel number assigned in the program guide and press ENTER.

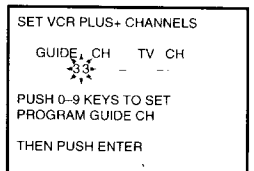

3

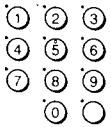

- If you made Hookup 1 or 3: Enter the actual number on your TV (and VCR) and press ENTER.
- If you made Hookup 2: Enter the cable output channel (usually 2, 3 or 4) and press ENTER.
- If you made Hookup 4: Enter the actual number on your TV (and VCR) for an unscrambled channel and press ENTER. For a scrambled channel, enter the cable box output channel (usually 2, 3, or 4) and press ENTER.

SET VCR PLUS+ CHANNELS

GUIDE	CH	TV	CH
	33	-	3

PUSH 0-9 KEYS TO SET PROGRAM TV CH
THEN PUSH ENTER

SET VCR PLUS+ CHANNELS

GUIDE	CH	TV	CH
	33	-	3

PUSH 0-9 KEYS TO SET PROGRAM TV CH
THEN PUSH ENTER

Getting Started

4

Repeat steps 2 and 3 for each channel whose numbers don't match.

5

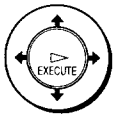

When you have set all channels, press the Joystick (EXECUTE) to confirm your channel settings.

VCR PLUS+ CHANNEL LIST

PAGE 1

GUIDE	TV	GUIDE	TV
2	- 73	59	- 47
5	- 4	61	- 3
17	- 55	77	- 35
28	- 9	86	- 120
33	- 5	90	- 22

USE ◀/▶ TO CHANGE PAGE
PUSH MENU TO QUIT

6



When you've finished, press MENU to exit.

Playing a tape

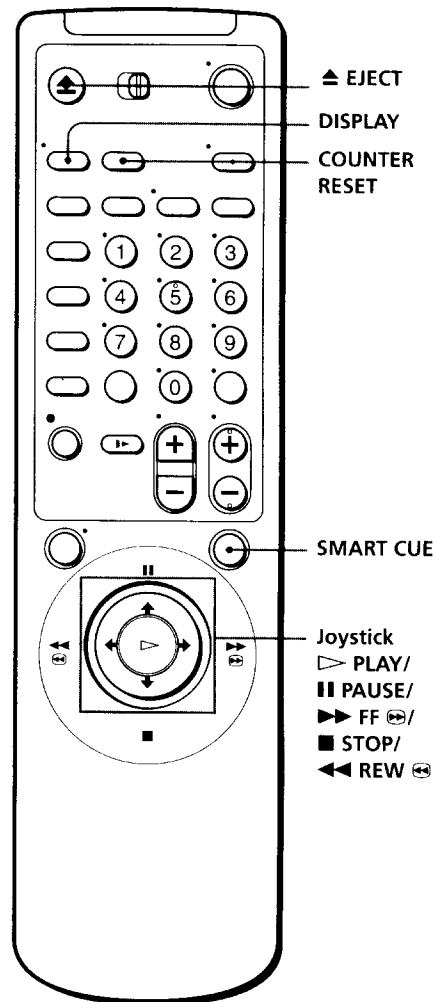

1 Turn on your TV and set it to the video channel.

2 Insert a tape.
The VCR turns on and starts playing automatically if you insert a tape with its safety tab removed.

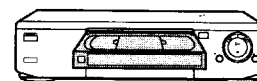

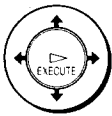

Press the Joystick \blacktriangleright .
When the tape reaches the end, it will rewind automatically.

Additional tasks

To	Push Joystick to
Stop play	■ STOP
Pause play	PAUSE
Resume play after pause	PAUSE or press the Joystick \blacktriangleright .
Search forward	$\blacktriangleright\blacktriangleright$ FF ⊕ during playback
Search backward	$\blacktriangleleft\blacktriangleleft$ REW ⊗ during playback
Fast-forward the tape	$\blacktriangleright\blacktriangleright$ FF ⊕ during stop
Rewind the tape	$\blacktriangleleft\blacktriangleleft$ REW ⊗ during stop
Eject the tape	Press \blacktriangle EJECT.

To skip playback

You can skip a portion of playback you don't want to watch such as a commercial and restart playback by pressing a single button.

Press SMART CUE during playback of a scene you want to skip. The VCR starts searching.

Press SMART CUE again when you find the scene you want to watch. The VCR stops searching, rewinds a few seconds, then resumes normal playback.

To use the time counter

At the point on the tape that you want to find later, press COUNTER RESET. The counter in the display window resets to "0H00M00S." Search for the point afterwards by referring to the counter.

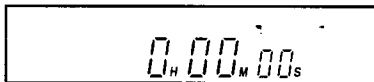

To display the counter on the TV screen, press DISPLAY.

Notes

- Tapes recorded in the LP mode on other VCRs can be played back on this VCR but the picture quality cannot be guaranteed.
- While setting the menu on the TV screen, you cannot use the Joystick for tape operation.
- The counter resets to "0H00M00S" whenever a tape is reinserted.
- The counter stops counting when it comes to a portion with no recording.

Recording TV programs

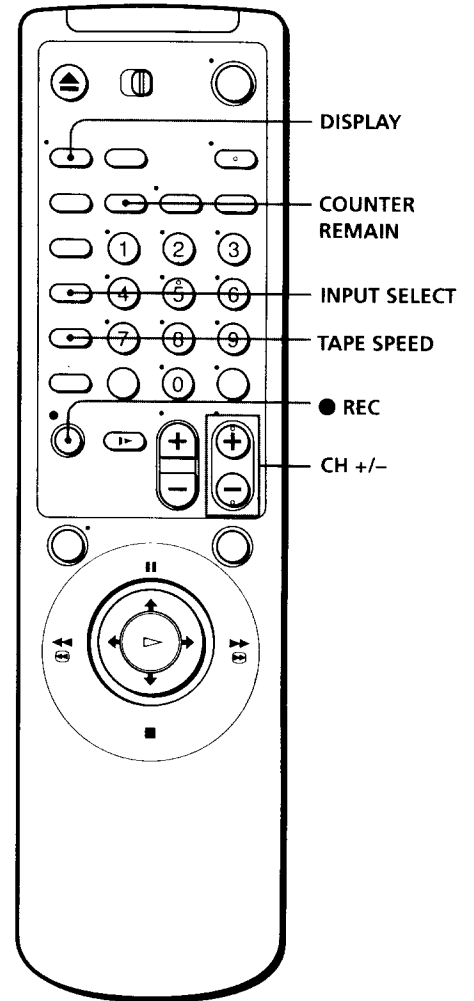

- 1** Turn on your TV and set it to the video channel.
To record from a cable box, turn it on.
- 2** Insert a tape with its safety tab in place.

3  Press INPUT SELECT until a channel number appears in the display window.

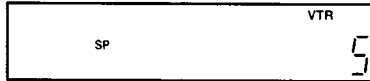

4  Press CH +/- to select the channel you want to record.



5  Press TAPE SPEED to select the tape speed, SP or EP. EP provides recording time three times as long as SP, however, SP produces better picture and audio quality.



6  Press ● REC to start recording.

To stop recording

Push Joystick to ■ STOP.

To check the remaining time

Press DISPLAY. With the display on, press COUNTER/REMAIN to check the remaining time. Each time you press COUNTER/REMAIN, the time counter and the remaining time appear alternately. The remaining time indicator also appears in the display window.

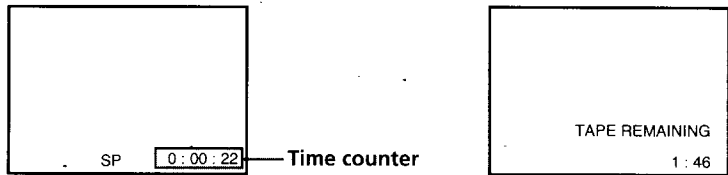

To check the remaining time of a T-140, T-180 or longer tape, set TAPE SELECT in the ADVANCED OPTIONS menu to "180." (For details, see page 67.)

continued

Recording TV programs (continued)

To watch another TV program while recording

- 1 Press TV/VTR to turn off the VTR indicator in the display window.
- 2 If the TV is connected to the VCR's LINE OUT jacks, set the TV to TV input; if not, skip this step.
- 3 Select another channel on the TV.

To save a recording

To prevent accidental erasure, break off the safety tab as illustrated. To record on a tape again, cover the tab hole with adhesive tape.

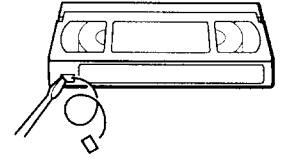

Safety tab

Tips

- To select a channel, you can use the number buttons on the remote commander. Enter the channel number, then press ENTER.
- You can select a video source from the LINE-1 IN or LINE-2 IN jacks using INPUT SELECT.
- The display appears on the TV screen indicating information about the tape, but the information won't be recorded on the tape.
- If you don't want to watch TV while recording, you can turn off the TV. When using a cable box, make sure to leave it on.

Notes

- The remaining time may not be indicated accurately for short tapes such as T-20 or T-30, or tapes recorded in the LP mode.
- The display doesn't appear during still (pause) mode, search mode or slow-motion playback.
- It may take up to one minute for the VCR to calculate and display the remaining time after you press DISPLAY.

Recording TV programs using VCR Plus+

Just enter the program's PlusCode listed in the TV program guide. The date, times and channel number of that program are set automatically. You can preset up to eight programs at a time.

Before you start...

- Check that the VCR clock is set to the correct time.
- Turn on your TV and set it to the video channel. When using a cable box, turn it on.
- Insert a tape with its safety tab in place. Make sure the tape is longer than the total recording time.

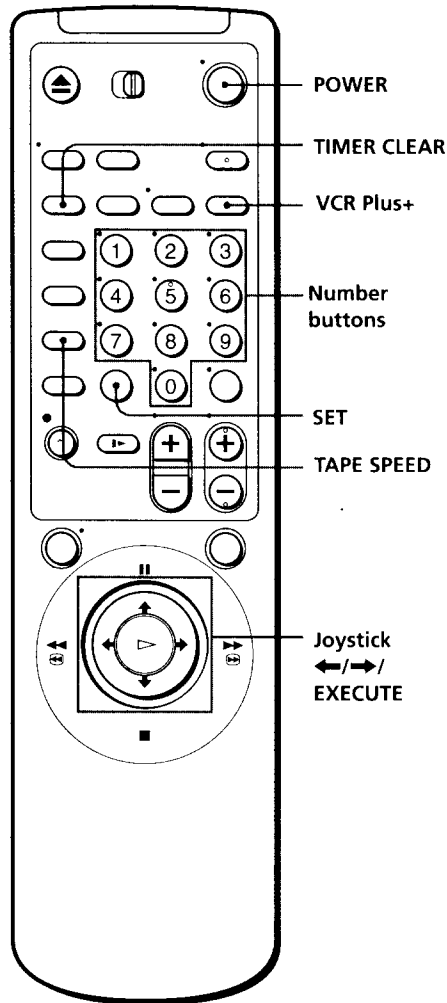

Basic Operations

1 VCR Plus+ Press VCR Plus+.

VCR PLUS+	TAPE SPEED
PLUSCODE	SP

ENTER PROGRAM'S PLUSCODE USING 0-9 KEYS	
TO CHANGE TAPE SPEED PUSH TAPE SPEED	

continued

Recording TV programs using VCR Plus+ (continued)

2

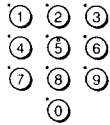

Press the number buttons to enter the program's PlusCode.

If you make a mistake, press **TIMER CLEAR** and re-enter the correct number.

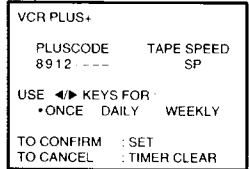

3



Press **TAPE SPEED** to select SP or EP.

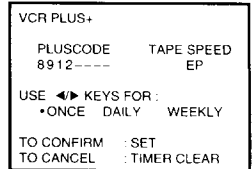

4

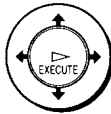

Select **ONCE**, **DAILY**, or **WEEKLY** by pushing Joystick to ◀/▶, then press **SET**:



To record	Select
Only once	ONCE
Everyday Monday to Friday	DAILY
Once a week	WEEKLY

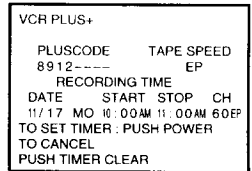

The date, start and stop times, channel number and tape speed appear on the TV screen. If the information is not correct, press **TIMER CLEAR** to cancel the setting.

5

To enter another setting, repeat steps 1 to 4.

6



Press **POWER** to turn off the VCR.

The **TIMER** indicator on the VCR lights up and the VCR stands by for recording. When using a cable box, leave it on.

To stop recording

To stop the VCR while recording, push Joystick to ■ **STOP**.

To use the VCR after setting the timer

To use the VCR before a timer recording begins, just press POWER. The TIMER indicator turns off and the VCR switches on. Remember to press POWER to reset the VCR in timer recording standby after using the VCR.

You can also do the following tasks while the VCR is recording:

- Reset the counter.
- Display tape information on the TV screen.
- Check the timer settings.
- Watch another TV program.

To lock the VCR after setting the timer (Child Lock)

Hold down POWER on the VCR until the VCR beeps. The VCR turns off and the  indicator appears in the display window. The VCR will not work except for timer recording.

To unlock the VCR, hold down POWER on the VCR until the VCR beeps. The VCR turns on and the  indicator disappears from the display window.

To stop timer recording while the VCR is locked, press  STOP on the VCR. The recording stops and the VCR is unlocked.

Tip

- To cancel the procedure, press VCR Plus+ before pressing SET.

Note

- If the VCR doesn't accept the PlusCode, this means that:
 - The PlusCode is incorrect.
 - ONCE, DAILY, or WEEKLY was selected incorrectly. You cannot select DAILY or WEEKLY for a program that airs more than seven days ahead.

Setting the timer manually

If VCR Plus+ is not available in your area, follow the instructions below to set the timer to record programs.

Before you start...

- Check that the VCR clock is set to the correct time.
- Turn on your TV and set it to the video channel. When using a cable box, turn it on.
- Insert a tape with its safety tab in place. Make sure the tape is longer than the total recording time.

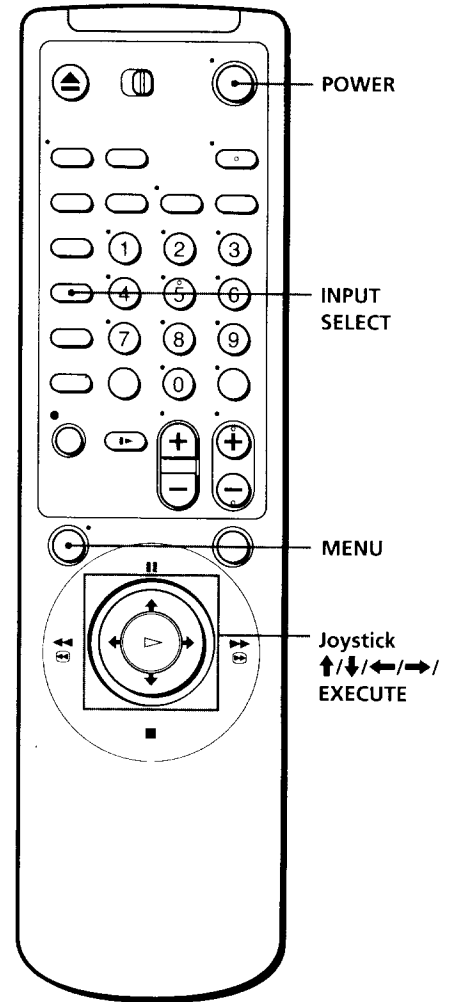

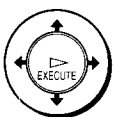
- 

Press MENU and select TIMER SET/CHECK, then press the Joystick (EXECUTE).

TIMER SET/CHECK	11/16	SU
DATE	START	STOP CH
▶-/-	-/-	-/-
-/-	-/-	-/-
-/-	-/-	-/-
-/-	-/-	-/-
-/-	-/-	-/-
-/-	-/-	-/-
-/-	-/-	-/-

2

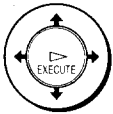

Set the date, start and stop times, channel number and tape speed:

- 1 Push Joystick to → to flash each item in turn.
 - 2 Push Joystick to ↑/↓ to set each item.
- To correct a setting, push Joystick to ← to return to that setting and reset.

TIMER SET / CHECK	11 / 16	SU
DATE	START	STOP
11 / 16 SU	---	---
-----	---	---
-----	---	---
-----	---	---
-----	---	---
-----	---	---
-----	---	---
-----	---	---
-----	---	---

To record the same program every day or the same day every week, push Joystick to ↓ while the date is flashing. For details, see "Daily/weekly recording" on this page.

To record from a source connected to the LINE IN jacks, press INPUT SELECT to display "L1" or "L2" in the "CH" position.

3

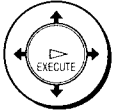

Push Joystick to → to confirm the setting.

The cursor (▶) appears at the beginning of the line. To enter another setting, move the cursor to the next line and repeat step 2.

4

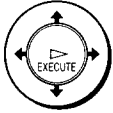

Press the Joystick (EXECUTE).

5

• POWER



Press POWER to turn off the VCR.

The TIMER indicator on the VCR lights up and the VCR stands by for recording. When using a cable box, leave it on.

Daily/weekly recording

In step 2 above, push Joystick to ↓ to select the recording pattern. Each time you push Joystick to ↓, the indication changes as shown below.

the current date → SU-SA → MO-SA → MO-FR → EVERY SA → →
 EVERY MO → EVERY SU → 1 month later → (dates count down) → the current date

Tips

- To set the channel, you can also use the CH+/- or number buttons.
- To set the tape speed, you can also use TAPE SPEED.

Note

- If you are using cable box control, you cannot select "L1" or "L2".

Playing/searching at various speeds

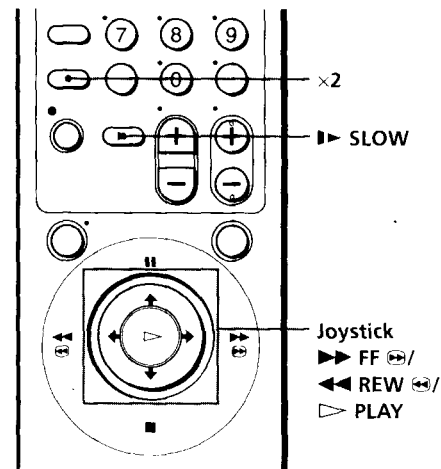

Playback options	Operation
Fast-forward/rewind	During stop, push Joystick to ►► FF or ◄◄ REW.
View the picture during fast-forward or rewind	During fast-forward, keep pushing Joystick to ►► FF. During rewind, keep pushing Joystick to ◄◄ REW.
Play at high speed	During playback, push Joystick to ►► FF or ◄◄ REW.
Play at twice the normal speed	During playback, press x2.
Play in slow motion	During playback or pause, press ► SLOW.
Play frame by frame	During pause, push Joystick to ►► FF or ◄◄ REW. Keep pushing Joystick to play one frame each second.
Rewind and start play	During stop, press ► PLAY on the VCR while pressing ◄◄ REW on the VCR.

To resume normal playback

Press the Joystick ►.

Tip

- Adjust the picture using the TRACKING +/- buttons on the VCR if:
 - Streaks appear while playing in slow motion.
 - The picture shakes while pausing.

Notes

- The sound is muted during these operations.
- Tapes recorded in the LP mode on other VCRs can be played back on this VCR but the picture quality cannot be guaranteed.
- The picture may have snow:
 - when playing at high speed in reverse
 - when playing in reverse slow motion
 - when playing in reverse.

Recording TV programs using the quick timer

After starting recording in the normal way, you can have the VCR stop recording automatically after a specified duration.

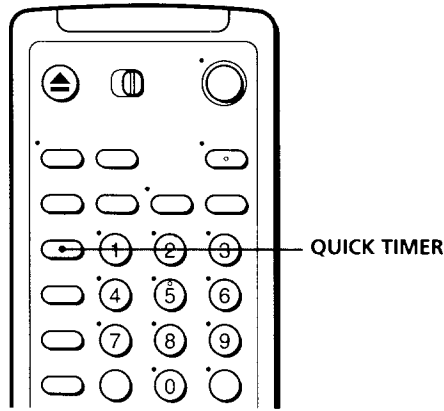

- 1 While recording, press QUICK TIMER once.

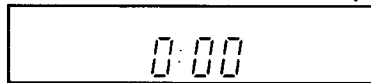

- 2 Press QUICK TIMER repeatedly to set the duration.
Each press advances the time in increments of 30 minutes.

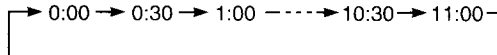

The duration decreases minute by minute to 0:00, then the VCR stops recording and turns off automatically.

To extend the duration

Press QUICK TIMER repeatedly to set to the new duration.

To stop the VCR while recording

Push Joystick to ■ STOP.

Using the quick timer during stop mode

- 1 Press QUICK TIMER.
- 2 Press CH +/- or INPUT SELECT to select the channel you want to record.
- 3 Press QUICK TIMER repeatedly to set the recording duration.
The recording starts.

Checking/ changing/ canceling timer settings

Before you start...

- Turn on your TV and set it to the video channel.

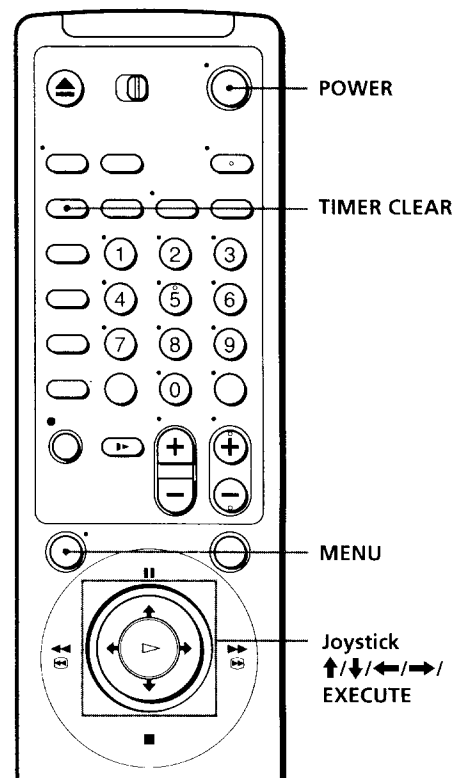

- 1 Press **POWER** to turn on the VCR.
- 2 Press **MENU** and select **TIMER SET/CHECK**:
 - If you want to change a setting, go on to the next step.
 - If you do not need to change the settings, press the Joystick (**EXECUTE**), then turn off the VCR to return to recording standby.

TIMER SET/CHECK	11/16	SU
DATE	START	STOP CH
▶11/17	MO 7:00AM	8:00AM 6SP
11/25	TU 10:30PM	11:15PM 50EP
MO - SA	1:00PM	3:00PM L1EP
EVERYSU	11:55AM	1:30PM 42SP
-/-	---	---
-/-	---	---
-/-	---	---
-/-	---	---

- 3 Push Joystick to **↑/↓** to select the setting you want to change or cancel:
 - To change the setting, push Joystick to **←/→** to flash the item you want to change, and push Joystick to **↑/↓** to reset it. Then, push Joystick to **→** repeatedly until the cursor (▶) appears at the beginning of the line.
 - To cancel the setting, press **TIMER CLEAR**.
- 4 Press the Joystick (**EXECUTE**).

If any timer settings remain, turn off the VCR to return to recording standby.

When the timer settings overlap

The program that starts first has priority and the second program starts recording only after the first program has finished. If the programs start at the same time, the program listed first in the menu has priority.

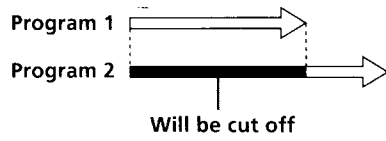

Recording stereo and bilingual programs

Recording stereo programs

This VCR automatically receives and records stereo programs. When a stereo program is received, the STEREO indicator lights up. If there is noise in the stereo program, set AUTO STEREO in the ADVANCED OPTIONS menu to OFF. The sound will be recorded in monaural (on both hi-fi and normal audio tracks) but with less noise. For details, see page 67.

Recording bilingual programs

Normally, this VCR records only the main sound. When a SAP (Second Audio Program) is received, the SAP indicator lights up. To record only SAP sound, set TUNER AUDIO in the ADVANCED OPTIONS menu to SAP. For details, see page 67.

Selecting the sound while playing

Press AUDIO MONITOR to select the desired sound. (The sound being recorded will not change.)

Stereo program

To listen to	Indicator on the TV screen
Stereo	STEREO
Left channel	L
Right channel	R
Monaural sound on the normal audio track*	No indicator appears

* Usually the mixed sound of left and right channels

How sound is recorded on a video tape

The VCR records sound onto two separate tracks. Hi-fi audio is recorded onto the main track along with the picture. Monaural sound is recorded onto the normal audio track along the edge of the tape.

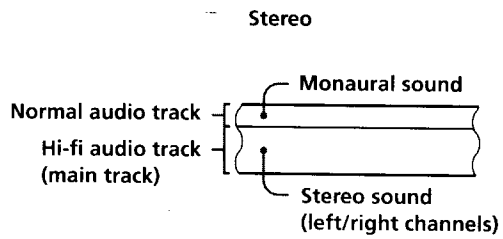



Notes

- To play a tape in stereo, you must use the A/V connections.
- When you play a tape recorded in monaural, the sound is heard in monaural regardless of the AUDIO MONITOR setting.

Adjusting the picture

Adjusting the tracking

Although the VCR automatically adjusts the tracking when playing a tape (the tracking indicator  flashes in the display window, then goes off), distortion may occur if the tape was recorded in poor condition. In this case, manually adjust the tracking.

Press the TRACKING +/- buttons on the VCR to display the tracking meter. The distortion should disappear as you press one of the two buttons (the  indicator lights up). To resume automatic tracking adjustment, eject the tape and reinsert it.

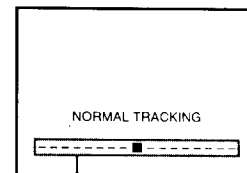

Tracking meter

About Adaptive Picture Control (APC)

Adaptive Picture Control (APC) automatically improves recording and playback quality by adjusting the VCR to the condition of the video heads and tape. To maintain better picture quality, we recommend that you set APC to ON in the ADVANCED OPTIONS menu (with the APC indicator in the display window lit).



APC playback

The APC function automatically works on all types of tapes, including rental tapes and tapes that were not recorded with APC.

APC recording

Whenever you insert a tape and first start recording, the VCR adjusts to the tape using the APC function (the APC indicator flashes rapidly). This adjustment is retained until the tape is ejected.

Notes

- Auto tracking adjustment cannot be guaranteed on tapes recorded in the LP mode on other VCRs.
- The APC function doesn't work if the tape speed is automatically changed from the SP to EP mode during a timer recording, unless the tape has been recorded in the EP mode with the APC function.
- There is a delay of a few seconds before the VCR actually starts recording while the VCR analyzes the tape. To avoid the delay, first set the VCR to recording pause (the APC indicator flashes slowly) and press  REC to have the VCR analyze the tape. After the APC indicator stops flashing, push Joystick to  PAUSE to start recording immediately. If you push Joystick to  PAUSE before the APC indicator stops flashing, the APC function is canceled.

Changing menu options

- 1 Press MENU and select ADVANCED OPTIONS.

ADVANCED OPTIONS		
▶ AUTO STEREO	• ON	OFF
TUNER AUDIO	• MAIN	SAP
APC	• ON	OFF
TAPE SELECT	• AUTO	180
AUTO TAPE SPEED	• ON	OFF
SHARPNESS	L	■ -- H

- 2 Push Joystick to ↑/↓ to select the option to change, then push Joystick to ←/→ to change the setting.
- 3 Press the Joystick (EXECUTE) to return to the original screen.

Menu choices

Initial settings are indicated in bold print.

Menu option	Set this option to
AUTO STEREO	ON to receive stereo programs. OFF to reduce noise; the sound changes to monaural.
TUNER AUDIO	MAIN to record the main sound. SAP to record the SAP (Second Audio Program) sound.
APC	ON to switch on the APC (Adaptive Picture Control) function and improve picture quality. OFF to switch off APC.
TAPE SELECT	AUTO or 180 (when using a T-140, T-180 or longer tape) to select the tape length and display the remaining time correctly.
AUTO TAPE SPEED	ON to change the timer recording tape speed automatically to the EP mode when the remaining tape becomes shorter than the recording time. OFF to keep the set tape speed.
SHARPNESS	L (Low) through H (High) to adjust the sharpness of the picture. L to turn off the sharpness control.

Editing with another VCR

How to hook up to record on this VCR

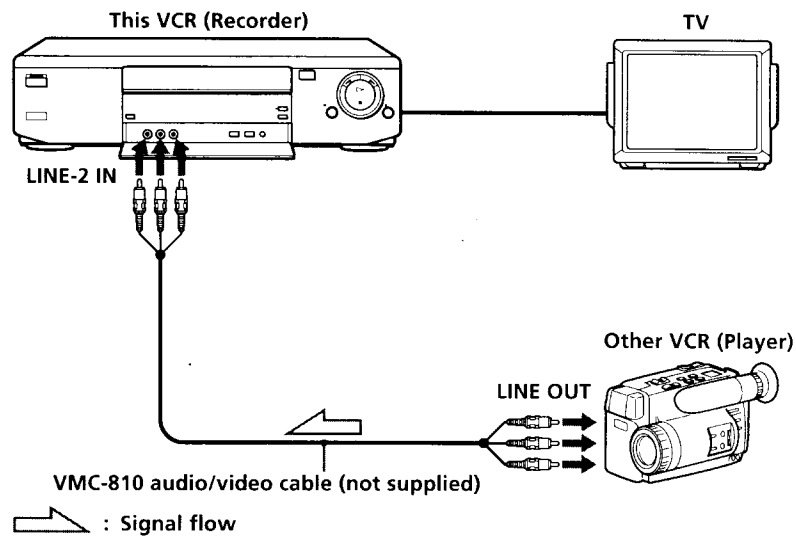

How to hook up to a stereo system

Connect LINE-2 IN AUDIO on this VCR to the audio output jacks on the stereo system, using the RK-C510KS audio cable (not supplied).

If the other VCR has a CONTROL S OUT jack for synchronized editing

Hook up to record on the other VCR, then connect the VCRs via the CONTROL S jacks. The CONTROL S connection lets you control (pause and release pause) both VCRs from the recording VCR.

Notes

- Make sure you connect the plugs to jacks of the same color.
- If the other VCR is a monaural type, connect the audio plug to the AUDIO L (white) jack. The sound is recorded on both right and left channels. When connecting to the AUDIO R (red) jack, the sound is recorded only on the right channel.
- If you connected this VCR to both the LINE IN and LINE OUT jacks of the other VCR, select the input correctly to prevent a humming noise.
- You can also use the LINE-1 IN jacks instead.

Operation

(when recording on this VCR)

Before you start editing

- Turn on your TV and set it to the video channel.
- Press INPUT SELECT on the remote commander to display "L1" or "L2" in the display window.
- Press TAPE SPEED on the remote commander to select the tape speed, SP or EP.

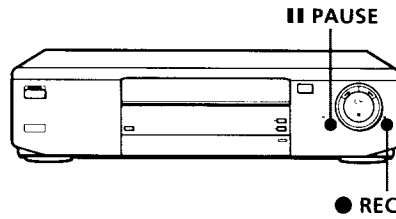

- 1** Insert a source tape with its safety tab removed into the other (playback) VCR. Search for the point to start playback and set it to playback pause.
- 2** Insert a tape with its safety tab in place into this (recording) VCR. Search for the point to start recording and press **|| PAUSE**.
- 3** Press **● REC** on this VCR and set it to recording pause.
- 4** To start editing, press the **|| PAUSE** buttons on both VCRs at the same time.

To stop editing

Press the **■ STOP** buttons on both VCRs.

Note

- If you start recording following the procedure above, the VCR won't start recording with the APC function. To record a tape with the APC function, press **● REC** again during recording pause in step 3 so that the VCR analyzes the tape. Then when you start recording in step 4, press **|| PAUSE** immediately after the APC indicator stops flashing. If you press **|| PAUSE** before the APC indicator stops flashing, the APC function is canceled.

General setup information

Setting the RF unit

When connecting the VCR to the TV using only the antenna cable, you must set the RF UNIT switch on the rear of the VCR so that the TV can receive the correct signal from the VCR.

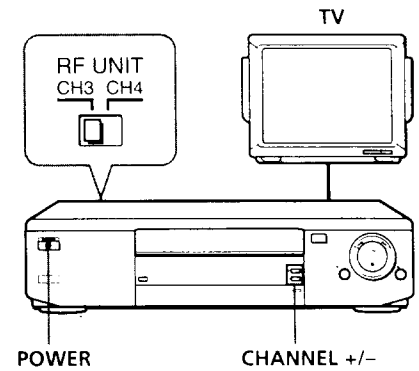

- 1** Set the RF UNIT switch on the rear of the VCR to CH 3 or CH 4, whichever channel is not used in your area. If both are used, set the switch to either channel.
- 2** Press POWER to turn on the VCR.
- 3** Press TV/VTR on the remote commander to turn on the VTR indicator in the VCR's display window.
- 4** Press CHANNEL +/- to display a channel number in the display window. Select an active channel number in your area.
- 5** Turn on your TV and set it to the channel you selected in step 1 (channel 3 or 4).

The selected TV channel broadcast appears on the TV screen. If the channels change when you press CHANNEL +/-, you have made the correct setting.

Whenever you use the VCR, set the TV to the channel selected in step 1.

Attaching the external antenna connector

When using a 300-ohm twin lead cable for VHF/UHF antenna, use the EAC-32 antenna connector (not supplied) to connect the antenna to the VCR.

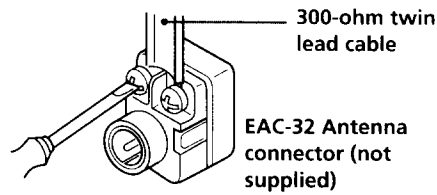

- 1 Loosen the screws on the antenna connector.
- 2 Wind the twin leads around the screws on the antenna connector.
- 3 Retighten the screws.

Attaching a UHF/VHF band mixer

When using both 75-ohm coaxial cable and 300-ohm twin lead cable for VHF/UHF antenna, use the EAC-66 UHF/VHF band separator/mixer (not supplied) to connect the antenna to the VCR.

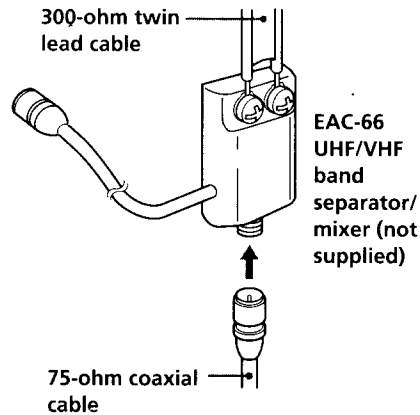

- 1 Loosen the screws on the mixer.
- 2 Wind the twin leads around the screws on the mixer.
- 3 Retighten the screws.
- 4 Connect the 75-ohm coaxial cable to the mixer.

Troubleshooting

If you have any questions or problems not covered below, please consult your nearest Sony dealer.

	Symptom	Remedy
Power	The POWER switch does not function.	<ul style="list-style-type: none"> • Connect the AC power cord securely. • Make sure the VCR is not locked. To unlock, hold down POWER on the VCR until the VCR beeps and the  indicator disappears.
	The power is turned on but the VCR does not operate.	<ul style="list-style-type: none"> • Moisture condensation occurs. Turn the power off, unplug the AC power cord and leave the VCR to dry for over an hour.
Clock	The clock has stopped and "--:--" lights in the display window.	<ul style="list-style-type: none"> • The clock stops if the VCR is disconnected from the wall outlet for more than one hour. Reset the clock (and timer).
Playback	The playback picture does not appear on the TV screen.	<ul style="list-style-type: none"> • Make sure the TV is set to the channel for the VCR. If you are using a monitor, set it to video input.
	The picture is not clear.	<ul style="list-style-type: none"> • Adjust the tracking with the TRACKING+/- buttons. • The video heads are dirty (see below). Clean the video heads using the Sony T-25CL video head cleaning cassette. If this cleaning cassette is not available in your area, have the heads cleaned at your nearest Sony service facility (a standard service charge will be required). Do not use a commercially available wet-type cleaning cassette, as it may damage the video heads. • The video heads may have to be replaced. Consult your local Sony dealer for more information.
	The picture rolls vertically during picture search.	<ul style="list-style-type: none"> • Adjust the vertical hold control on the TV or monitor.
	The picture has no sound.	<ul style="list-style-type: none"> • The tape is defective. Use a new tape.

Symptoms caused by contaminated video heads

• Normal picture



• Rough picture



• Unclear picture



• No picture (or black & white screen appears)



initial  terminal

	Symptom	Remedy
Recording	A TV program does not appear on the TV screen.	<ul style="list-style-type: none"> • Make sure the TV is set to the channel for the VCR. If you are using a monitor, set it to video input.
	TV reception is poor.	<ul style="list-style-type: none"> • Adjust the TV antenna.
	The tape starts playing as soon as it is inserted.	<ul style="list-style-type: none"> • The safety tab has been removed. To record on this tape, cover the tab hole.
	The tape ejects when you press ● REC.	<ul style="list-style-type: none"> • Check that the safety tab has not been removed.
Timer recording	Nothing happens when you press ● REC.	<ul style="list-style-type: none"> • Make sure the tape is not at its end. • Select the correct source. Select a channel number with the CH +/- buttons when recording TV programs; select "L1" or "L2" with the INPUT SELECT button when recording from other equipment.
	The timer does not operate.	<ul style="list-style-type: none"> • Check that the clock is set. • Make sure a tape has been inserted. • Check that the safety tab has not been removed. • Make sure the tape is not at its end. • Make sure a program has been set for timer recording. • Make sure your timer settings have not already passed the current time. • Check that the cable box is turned on. • The clock stops if the VCR is disconnected from the wall outlet for more than one hour. Reset the clock and timer.
Others	A tape cannot be inserted.	<ul style="list-style-type: none"> • Check that a tape isn't already in the tape compartment.
	The remote commander does not function.	<ul style="list-style-type: none"> • Make sure you are pointing the remote commander at the remote sensor on the VCR. • Replace all the batteries in the remote commander with new ones if they are weak. • Make sure the <input type="checkbox"/>TV / <input type="checkbox"/>VTR remote control switch is set correctly.
	The tracking indicator does not appear on the screen.	<ul style="list-style-type: none"> • The recording condition of the tape is very poor and tracking cannot be adjusted.
	You cannot control other TVs.	<ul style="list-style-type: none"> • Set your TV's code number. The code number resets to 01 when you replace the batteries of the remote commander.
	The VCR needs to be cleaned.	<ul style="list-style-type: none"> • Clean the cabinet, panel and controls with a dry, soft cloth, or a soft cloth slightly moistened with a mild detergent solution. Do not use any type of solvent, such as alcohol or benzine.

Specifications

System

Format
VHS NTSC standard

Video recording system
Rotary head helical scanning FM system

Video heads
Double azimuth four heads

Video signal
NTSC color, EIA standards

Tape speed
SP: 33.35 mm/s (1 3/8 inches/s)
EP: 11.11 mm/s (7/16 inches/s)
LP: 16.67 mm/s (1 1/16 inches/s),
playback only

Maximum recording/playback time
8 hrs. in EP mode (with T-160 tape)

Fast-forward and rewind time
Approx. 3 min. (with T-120 tape)

Tuner section

Channel coverage
VHF 2 to 13
UHF 14 to 69
CATV A-8 to A-1, A to W, W+1 to W+84

Antenna
75-ohm antenna terminal for VHF/UHF

Inputs and outputs

LINE-1 IN and -2 IN
VIDEO IN, phono jack (1 each)
Input signal: 1 Vp-p, 75 ohms, unbalanced,
sync negative
AUDIO IN, phono jack (2 each)
Input level: 327 mVrms
Input impedance: more than 47 kilohms

LINE OUT
VIDEO OUT, phono jack (1)
Output signal: 1 Vp-p, 75 ohms, unbalanced,
sync negative
AUDIO OUT, phono jack (2)
Standard output: 327 mVrms
Load impedance: 47 kilohms
Output impedance: less than 10 kilohms

S LINK (CONTROL S IN)
Mini jack (1)

CABLE BOX CONTROL (CONTROL S OUT)
Stereo mini jack (plug in power) (1)

Timer section

Clock
Quartz locked

Timer indication
12-hour cycle

Timer setting
8 programs per month (max.)

Power back-up
Built-in self-charging capacitor
Back-up duration: up to 1 hour at a time

General

Power requirements
120 V AC, 60 Hz (SLV-775HF/776HF)
110 V AC to 240 V AC, 50/60 Hz (SLV-775HF
PX)

Power consumption
24 W (SLV-775HF/776HF)
20 W (SLV-775HF PX)

Operating temperature
5°C to 40°C (41°F to 104°F)

Storage temperature
-20°C to 60°C (-4°F to 140°F)

Dimensions
Approx. 430 × 109 × 308 mm (w/h/d)
(Approx. 17 × 4 3/8 × 12 3/4 inches) including
projecting parts and controls

Mass
Approx. 4.5 kg (8 lb 13 oz)

Supplied accessories

Remote commander (1)
Size AA (R6) batteries (2)
75-ohm coaxial cable with F-type connectors (1)
Audio/video cable (3 phono and 1 mini to 3 phono
and 1 mini) (1)
Cable Mouse (cable box controller) (1)
Plug adaptor (1) (SLV-775HF PX)

Design and specifications are subject to change
without notice.

Index to parts and controls

Refer to the pages indicated in parentheses () for details.

Front panel

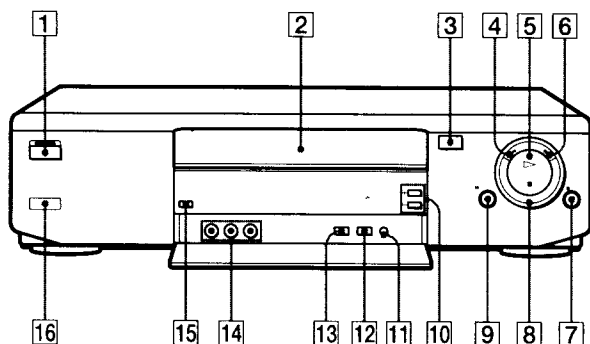

- | | |
|-----------------------------------|---|
| 1 POWER switch/indicator | 10 CHANNEL/TRACKING +/- buttons (53, 60, 66) |
| 2 Tape compartment | 11 EASY SET UP button (11, 14, 17, 20, 23, 26) |
| 3 ▲ EJECT button (51) | 12 TAPE SPEED button (53, 56) |
| 4 ◀▶ REW button (51, 60) | 13 INPUT SELECT button (53) |
| 5 ▷ PLAY button (51, 60) | 14 LINE-2 IN VIDEO/AUDIO L/R jacks (68) |
| 6 ▶▶ FF button (51, 60) | 15 TV/VTR button (54) |
| 7 ● REC button (53, 69) | 16 Remote sensor (5) |
| 8 ■ STOP button (51) | |
| 9 PAUSE button (51, 69) | |

continued

Display window

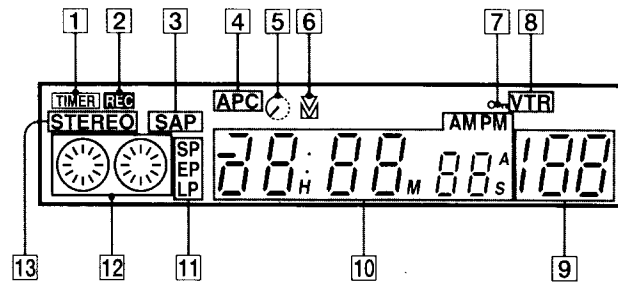

- | | | | |
|---|-------------------------------|----|---------------------------------------|
| 1 | TIMER indicator (56, 59) | 8 | VTR indicator (54) |
| 2 | REC (recording) indicator | 9 | Line/channel indicator |
| 3 | SAP indicator (64) | 10 | Time counter/clock indicator (51, 53) |
| 4 | APC indicator (66) | 11 | Tape speed indicator (53) |
| 5 | Remaining time indicator (53) | 12 | Tape indicator |
| 6 | ☒ (tracking) indicator (66) | 13 | STEREO indicator (64) |
| 7 | ☞ (Child Lock) indicator (57) | | |

Rear panel

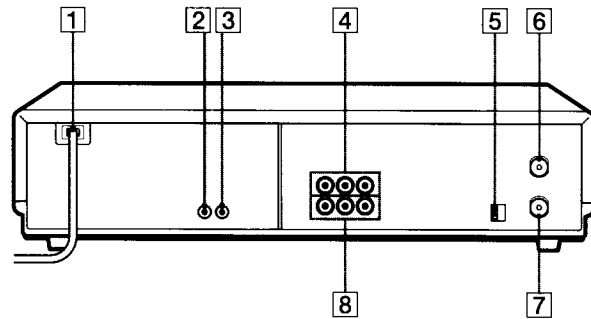

- | | | | |
|---|---|---|--|
| 1 | AC power cord | 5 | RF UNIT switch (70) |
| 2 | S LINK (CONTROL S IN) jack (9, 68) | 6 | VHF/UHF IN connector (10, 13, 16, 19, 22, 25) |
| 3 | CABLE BOX CONTROL (CONTROL S OUT) jack (10, 22) | 7 | VHF/UHF OUT connector (10, 13, 16, 19, 22, 25) |
| 4 | LINE-1 IN AUDIO L/R/VIDEO jacks (22, 68) | 8 | LINE OUT AUDIO L/R/VIDEO jacks (8) |

Remote commander

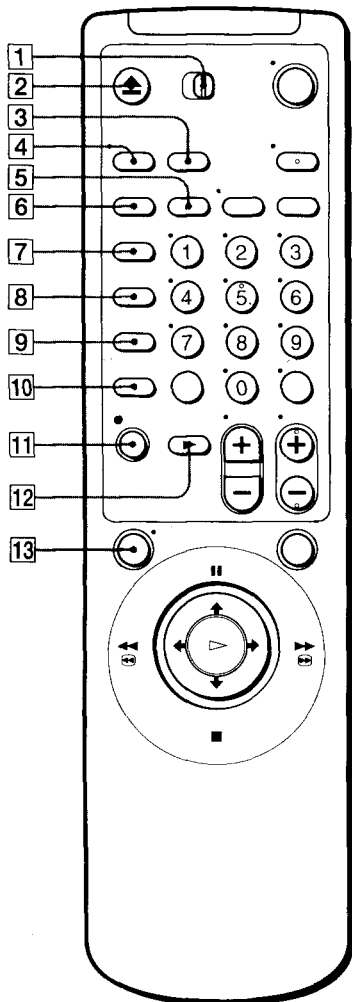

- 1 [TV/VTR] remote control switch (5)
- 2 ▲ EJECT button (51)
- 3 COUNTER RESET button (51)
- 4 DISPLAY button (51, 53)
- 5 COUNTER/REMAIN button (53)
- 6 TIMER CLEAR button (56, 62)
- 7 QUICK TIMER button (61)
- 8 INPUT SELECT button (53, 59, 69)
- 9 TAPE SPEED button (53, 56)
- 10 ×2 button (60)
- 11 ● REC button (53, 69)
- 12 ► SLOW button (60)
- 13 MENU button (30, 67)

continued

Remote commander (continued)

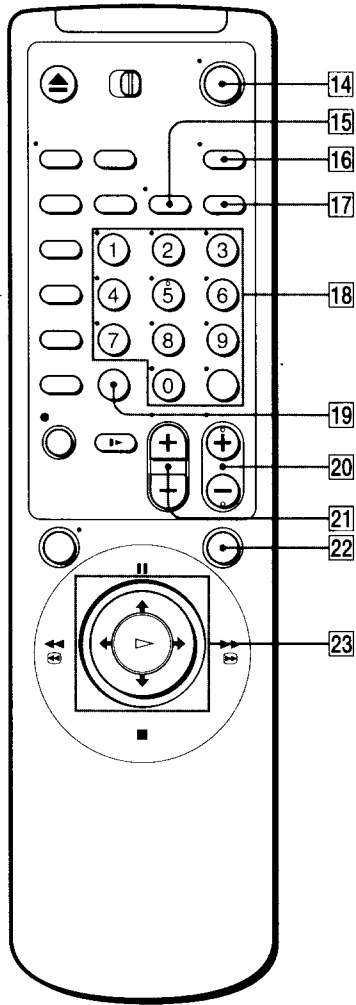

- 14 POWER switch (56)
 - 15 TV/VTR button (54)
 - 16 AUDIO MONITOR button (64)
 - 17 VCR Plus+ button (55)
 - 18 Number buttons and ENTER button (45, 48, 56)
 - 19 SET button (56)
 - 20 CH +/- buttons (45, 53)
 - 21 VOL +/- buttons
 - 22 SMART CUE button (51)
 - 23 Joystick (51, 60)
- ↑/↓/←/→/▷ PLAY/
EXECUTE/|| PAUSE/■ STOP/
▶▶ FF ◀◀ REW

Index

A, B

- Accessories supplied 4
- Adjusting
 - picture 46, 60, 66
 - tracking 60, 66
- AFT (Auto Fine Tuning) 46
- Antenna hookup 16
- APC (Adaptive Picture Control) 66
- Audio track 65
- Audio/video (A/V) hookup 8

C

- Cable box control
 - cable box code number chart 39
 - setting 38
- Cable hookup 10
- Cable mouse 41
- Canceling timer settings 62
- Changing timer settings 62
- Channel line-up chart 47
- Child Lock 57
- Cleaning the video heads 72
- Clock setting 31
- Connecting
 - cable TV 10
 - external antenna connector 71
 - UHF/VHF band mixer 71
- Counter 51

D

- Disabling channels 45
- DSS (Digital Satellite System) 38
- Dubbing: *See* Editing.

E, F, G

- Easy Set Up 11, 14, 17, 20, 23, 26
- Editing 48
- EP mode 53

H, I, J, K

- Hi-fi audio track 65

L

- Language selecting 30
- Locking the VCR 57
- LP mode 51, 60

M

- Monitoring audio 64

N, O

- Normal audio track 65

P

- Picture adjustment. *See* Adjusting.
- Playback 50
 - at various speeds 60
 - frame-by-frame 60
 - skip 51
 - slow motion 60
- Presetting channels 43

Q

- Quick timer 61

R

- Recording 52
 - bilingual programs 64
 - SAP broadcasts 64
 - saving 54
 - stereo broadcasts 64
 - using VCR Plus+ 55
 - while watching another program 54

S

- Safety tab 54
- SAP (Second Audio Program) 64
- Searching at various speeds 60
- SP mode 53

T, U

- Timer recording 58
 - canceling timer settings 62
 - changing timer settings 62
 - checking timer settings 62
 - daily/weekly recording 59
 - overlapping timer recordings 63
 - using VCR Plus+ 55
- Tracking adjustment. *See* Adjusting.

V, W, X, Y, Z

- VCR Plus+ 55
 - channel setup 47
 - recording 55

Quick reference to using the VCR

Hookup 1

To play a tape

- 1 Set the TV to channel 3 or 4 (or to video input, if you made A/V connections.)
- 2 Insert a tape and press the Joystick ▷.

To record a program

- 1 Turn on the cable box.
- 2 Press VCR Plus+ on the remote commander.
- 3 Enter the program's PlusCode number.
- 4 Select ONCE, DAILY, or WEEKLY, then press SET.
- 5 Insert a tape.
- 6 Press POWER to turn off the VCR.
- 7 Leave the cable box on.

To watch TV

- 1 Turn off your VCR, or press the VCR's TV/VTR button until the VTR indicator in the display window goes off.
- 2 Turn on your cable box.
- 3 Set the TV to the cable box output channel (usually 2, 3, or 4).
- 4 Set the cable box to the channel you want to watch.

Hookup 2

To play a tape

- 1 If you made A/V connections, set the TV to video input. If you didn't use A/V hookup:
 - Turn on the cable box.
 - Set the cable box to channel 3 or 4.
 - Set the TV to the output channel of the cable box (usually 2, 3, or 4).

- 2 Insert a tape and press the Joystick ▷.

To record a program

- 1 Press VCR Plus+ on the remote commander.
- 2 Enter the program's PlusCode number.
- 3 Select ONCE, DAILY, or WEEKLY, then press SET.
- 4 Insert a tape.
- 5 Press POWER to turn off the VCR.

To watch TV

- 1 Turn off your VCR, or press the VCR's TV/VTR button until the VTR indicator in the display window goes off.
- 2 Select the channel with your cable box (if you have one) or with your TV.

Hookup 3

To play a tape

- 1 Set the TV to channel 3 or 4 (or to video input, if you made A/V connections.)
- 2 Insert a tape and press the Joystick ▷. If there's no picture on your TV, press the VCR's TV/VTR button until the VTR indicator comes on in the display window.

To record a program

- 1 Press VCR Plus+ on the remote commander.
- 2 Enter the program's PlusCode number.
- 3 Select ONCE, DAILY, or WEEKLY, then press SET.
- 4 Insert a tape.
- 5 Press POWER to turn off the VCR.

To watch TV

- 1 Turn off the VCR, or press the VCR's TV/VTR button until the VTR indicator in the display window goes off.
- 2 Set the TV to the channel you want to watch.

Hookup 4

To play a tape

- 1 Set the TV to channel 3 or 4 (or to video input, if you made A/V connections.)
- 2 Insert a tape and press the Joystick ▷.

To record a program

- 1 Turn on the cable box.
- 2 Set the cable box to the channel you want to record.
- 3 Press VCR Plus+ on the remote commander.
- 4 Enter the program's PlusCode number.
- 5 Select ONCE, DAILY, or WEEKLY, then press SET.
- 6 Insert a tape.
- 7 Press POWER to turn off the VCR.
- 8 Leave the cable box on.

To watch TV

- 1 Turn off your VCR, or press the VCR's TV/VTR button until the VTR indicator in the display window goes off.
- 2 Turn on your cable box.
- 3 Set the TV to the cable box output channel (usually 2, 3, or 4).
- 4 Set the cable box to the channel you want to watch.

If you have any questions about this product, you may call: **Sony Customer Information Center** 1-800-222-SONY (7669) or write to: **Sony Customer Information Center** Sony Drive, Mail Drop #T1-11, Park Ridge, NJ 07656

Sony Corporation Printed in Malaysia